



TriMed Technologies

Customise Surgical Solution & Instruments

4/E-1, Second Floor, Nuchana Tower,

Alaknanda Shopping Complex, Alaknanda, New Delhi - 110019 (INDIA)

Ph:- +91-11-41051188, Mobile:-+91-8459130431

Email: trimedtechnologies@gmail.com, info@trimed.co.in

Web: www.trimed.co.in



Neuro/ Spinal Surgery

Forceps	115
Scissors	117
Dissectors and Probes	118
Hooks and Currettes	119
Retractors	120
Elevators	123
Suction Tubes	124
Rongeurs	125

Adson Dissecting Forceps

Bayonet, 1-2 teeth, jaw 2.5mm at tip



Code	Description
SC-NEU/001c	191mm long

Jefferson Dressing Forceps



Code	Description
SC-NEU/013	Serrated jaws, 178mm long

Adson Dissecting Forceps

Bayonet, fine, serrated jaws, jaw 2.5mm at tip

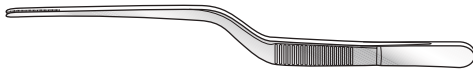

Code	Description
SC-NEU/009	178mm long

Jefferson Forceps



Code	Description
SC-NEU/002	Fine, 1-2 teeth, 178mm long

Northfield Dressing Forceps

Extra light, serrated jaws



Code	Description
SC-NEU/014	1mm wide, 203mm long

Pennybacker Dissecting Forceps



Code	Description
SC-NEU/005	3-4 teeth, 165mm long

Forceps

Silcock Iris Forceps

102mm long



Code	Description
SC-NEU/006	1-2 teeth
SC-NEU/015	Serrated jaws

Dott Dissecting Forceps

Fine, 1-2 teeth



Code	Description
SC-NEU/004	178mm long

Cairns Dissecting Forceps

Delicate, 2-3 teeth



Code	Description
SC-NEU/003a	165mm long
SC-NEU/003b	216mm long

Dott Dressing Forceps

Angled

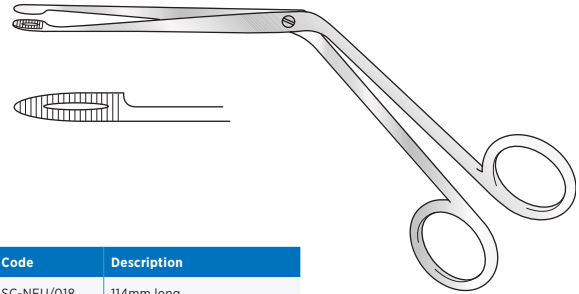

Code	Description
SC-NEU/018	114mm long

Cairns (Dott) Dressing Forceps

Serrated jaws



Code	Description
SC-NEU/010	Medium, 2mm wide, 216mm long
SC-NEU/012	Fine, 1mm wide, 178mm long

Tilley Dressing Forceps

Angled, serrated ends

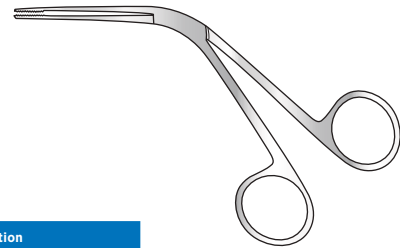

Code	Description
SC-NEU/017	89mm long

Cairns Scissors

Angled on flat

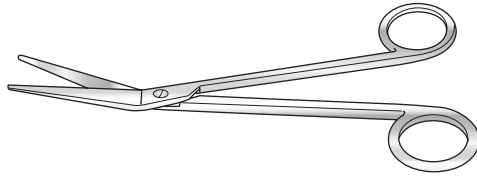

Code	Description
SC-NEU/020	178mm long

Olivecrona Scissors

Angled, with all micro serrated blade

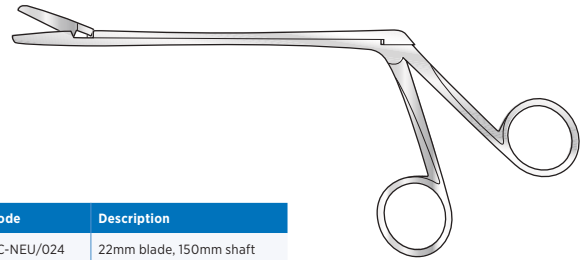

Code	Description
SC-NEU/024	22mm blade, 150mm shaft

McKissock Scissors

Straight

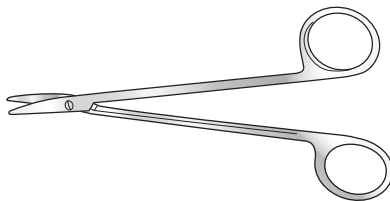

Code	Description
SC-NEU/021a	146mm long

Schmieden (Taylor) Scissors

Angled, probe-pointed under blade

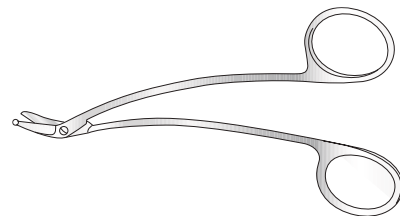

Code	Description
SC-NEU/023	146mm long

Sweet Scissors

Delicate

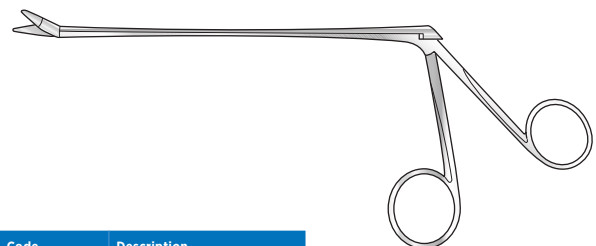

Code	Description
SC-NEU/025a	7mm blade, 144mm shaft
SC-NEU/030	13mm blade, 117mm shaft

The Original Titanium Rhoton Dissector Set

from Symmetry Surgical



+
19 dissectors
in a purpose
designed
case

- ✓ Made from lightweight titanium for balance, durability and corrosion resistance
- ✓ Design features include round, deeply knurled handles which facilitate non-slip, finger-controlled micro manipulation

Order your set today
info@surgicalholdings.co.uk

Dissectors and Probes

Cairns Guide and Director

Malleable



Code	Description
SC-NEU/080	127mm long

Pennybacker Probe Dissector

Double ended



Code	Description
SC-NEU/101	229mm long

Dissector

200mm long



Code	Description
SC-NEU/N30210	Soft
SC-NEU/N30220	Soft, with hole

Swedish Dissector

Double ended



Code	Description
SC-NEU/100a	Light model, 178mm long
SC-NEU/100b	Heavy model, 200mm long

Penfield Dissector



No 1

Broad curve, with 7.5mm sharp round spoon, 184mm long



No 2

7.5mm sharp round spoon with wax packer, 178mm long



No 3

Full curve and wax packer, 197mm long



No 4

Slight curve, 4mm wide, 216mm long

Code	Description
SC-NEU/069a	No 1
SC-NEU/069b	No 2
SC-NEU/069c	No 3
SC-NEU/069d	No 4

Watson Cheyne Dissector

Fine, double-ended, with probe end



Code	Description
SC-GI/287	127mm long
SC-GI/288	191mm long
SC-GI/288a	230mm long
SC-GI/288b	255mm long

Hooks and Curettes

Hooks

Adson Hook

178mm long



Code	Description
SC-NEU/078a	Angled
SC-NEU/078b	Straight
SC-NEU/078b-b	Straight, blunt

Adson Oliver Neuro Hook

191mm long

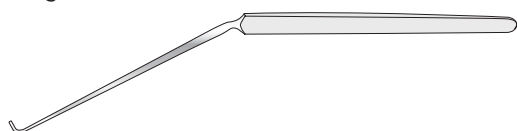

Code	Description
SC-NEU/082a	Angled downward, blunt
SC-NEU/082b	Sharp
SC-NEU/082c	Angled upward, blunt

Cairns Tissue Hook

127mm long



Code	Description
SC-NEU/081b	Half round, sharp
SC-NEU/081c	Angled, sharp

Oliver Tissue Hook

Blunt



Code	Description
SC-NEU/081a	127mm long

Curettes

Falconer Scoop Curette

Double ended, angled ends



Code	Description
SC-NEU/099	191mm long

American Spinal Fusion Curettes

Blue acetal handles, 254mm long



Straight

Code	Description
SC-NEU/074a	Size 000 2mm x 4mm
SC-NEU/074b	Size 00 2.5mm x 4.5mm
SC-NEU/074c	Size 0 2.75mm x 5mm
SC-NEU/074d	Size 1 3mm x 5.5mm
SC-NEU/074e	Size 2 3.25mm x 6mm
SC-NEU/074f	Size 3 4mm x 7mm
SC-NEU/074g	Size 4 6mm x 9.5mm
SC-NEU/074h	Size 5 7mm x 14mm
SC-NEU/074i	Size 6 9mm x 17mm

Angled

Code	Description
SC-NEU/074j	Size 000 2mm x 4mm
SC-NEU/074k	Size 00 2.5mm x 4.5mm
SC-NEU/074l	Size 0 2.75mm x 5mm
SC-NEU/074m	Size 1 3mm x 5.5mm
SC-NEU/074n	Size 2 3.25mm x 6mm
SC-NEU/074o	Size 3 4mm x 7mm
SC-NEU/074p	Size 4 6mm x 9.5mm
SC-NEU/074q	Size 5 7mm x 14mm
SC-NEU/074r	Size 6 9mm x 17mm

ALSO AVAILABLE WITH ACETAL SUREGRIP HANDLE
ADD SUFFIX BH TO CATALOGUE NUMBER

Retractors

Mastoid Retractor

3 x 3 blunt hooks

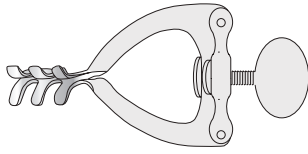

Code	Description
SC-NEU/N30350	114mm long

Henderson Retractor

Self retaining, straight, 4 x 4 blunt pointed blades

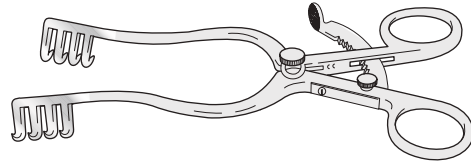

Code	Description
SC-NEU/030a	178mm long

Jansen (Shea) Retractor

Self retaining, blunt blades

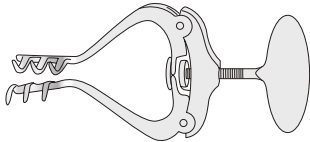

Code	Description
SC-NEU/028	114mm long

Cairns Scalp Retractor

Curved, self retaining, swivel blades

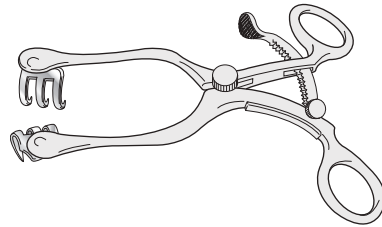

Code	Description
SC-NEU/025b	140mm long

Cone Retractor

Self retaining, hinged arms, for use in ventriculography

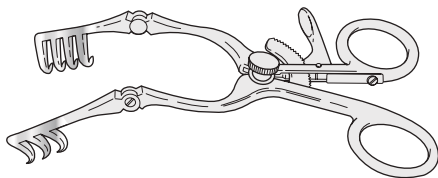

Code	Description
SC-NEU/027	165mm long

Schnitker Scalp Retractor

Curved, self retaining, blunt swivel blades

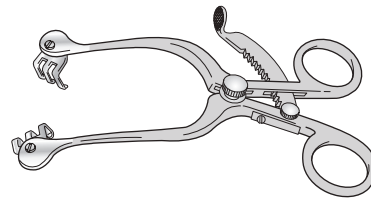

Code	Description
SC-NEU/026	140mm long

Jefferson Retractor

Self retaining, curved, blunt pointed blades

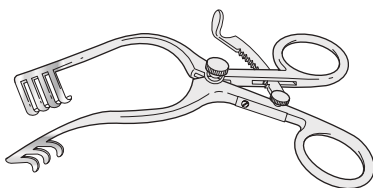

Code	Description
SC-NEU/029	140mm long

Cone Laminectomy Retractor

Hinged arms, with cam rack

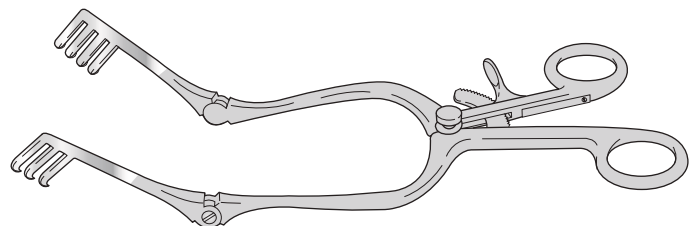

Code	Description
SC-NEU/051	254mm long

Cone Laminectomy Retractor

Hinged arms

Code	Description
SC-NEU/052a	Left, 165mm long
SC-NEU/052b	Right, 165mm long
SC-NEU/052c	Left, 254mm long
SC-NEU/052d	Right, 254mm long

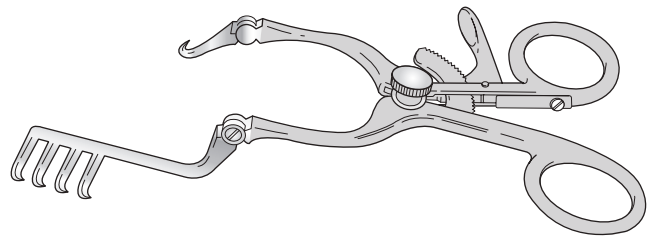

Harvey-Jackson Laminectomy Retractor

Hinged arms, blades 38mm wide x 44mm deep

Code	Description
SC-NEU/053	305mm long

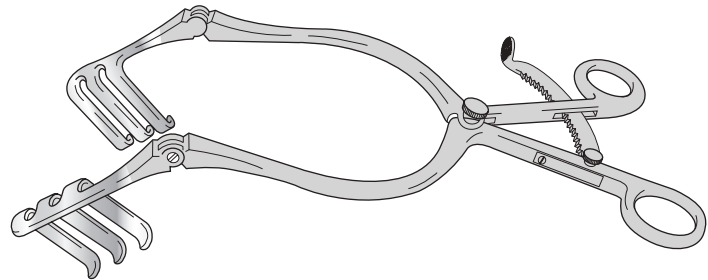

Mayo-Adson (Beckmann) Laminectomy Retractor

Hinged arms

Code	Description
SC-NEU/054	292mm long

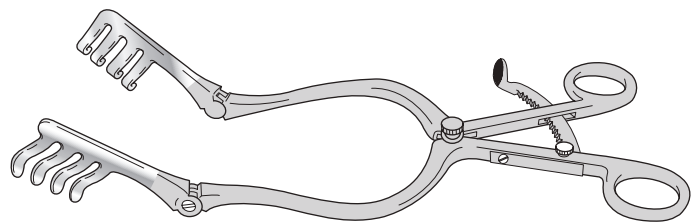

Northfield (Cairns) Retractor

Hinged arms, one pair of blades

4 prong : 25mm wide x 16mm deep
and one pair of blades

5 prong: 32mm wide x 25mm deep

Code	Description
SC-NEU/055	292mm long

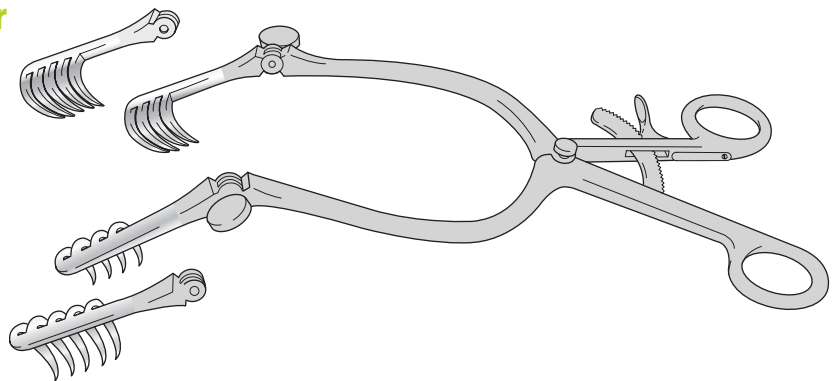

Meyerding Hemi-Laminectomy Retractor

Code	Description
SC-NEU/216	18cm long 7" blade size 50 x 10mm
SC-NEU/219	18cm long 7" blade size 50 x 20mm
SC-NEU/217	18cm long 7" blade size 60 x 10mm
SC-NEU/220	18cm long 7" blade size 60 x 20mm
SC-NEU/218	18cm long 7" blade size 70 x 10mm
SC-NEU/221	18cm long 7" blade size 70 x 20mm
SC-NEU/224	18cm long blade left 90 x 10mm
SC-NEU/225	18cm long blades left 90 x 20mm
SC-NEU/222	18cm long blades right 90 x 10mm
SC-NEU/223	18cm long blades right 90 x 20mm

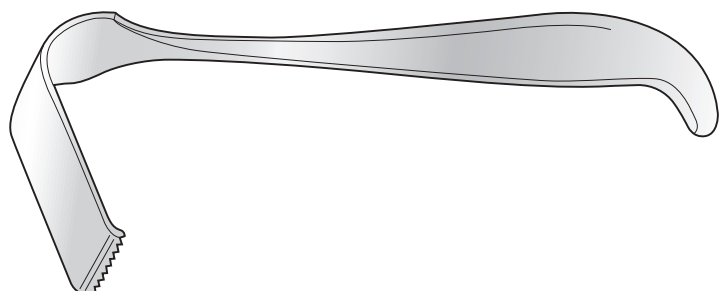

Retractors

Cairns-Northfield Laminectomy Retractor

203mm arm length with three pairs of interchangeable swivelling blades, 76mm, 64mm, and 51mm

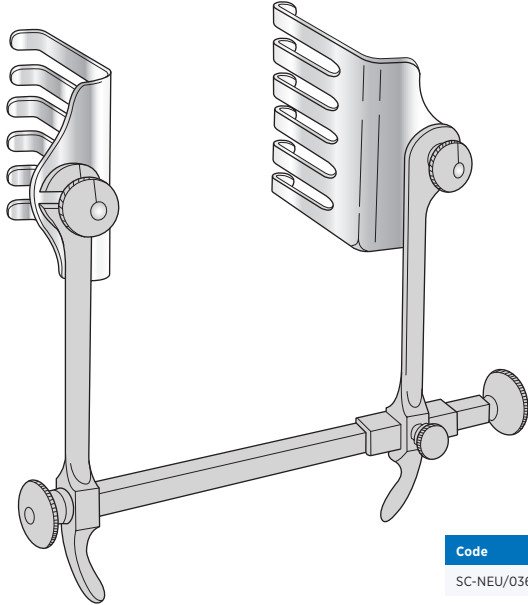

Code
SC-NEU/036

Hibbs Retractor

203mm long



Code	Description
SC-NEU/050a	Blades 10mm x 38mm
SC-NEU/050b	Blades 16mm x 54mm

Krayenbuhl Retractor

6mm wide

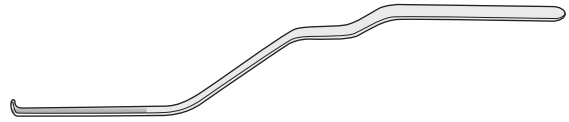

Code	Description
SC-NEU/5905	210mm long
SC-NEU/5905a	240mm long

Cairns 'Rake' Scalp Retractor

Sharp, 210mm long

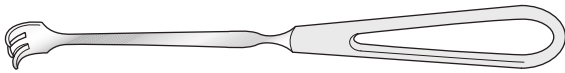

Code	Description
SC-NEU/032a	3 prong, 16mm wide
SC-NEU/032b	4 prong, 19mm wide

Love Retractor

6mm wide

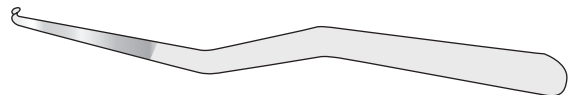

Code	Description
SC-NEU/5905b	210mm long

Cairns (Cushing) Scalp Retractor

Solid blade

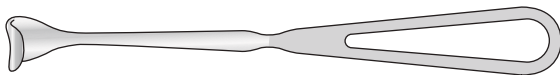

Code	Description
SC-NEU/033	16mm wide, 210mm long

Love Retractor

203mm long



Code	Description
SC-NEU/077a	Straight, blade 5mm x 5mm
SC-NEU/077b	Shaft angled 90° at handle
SC-NEU/077c	Shaft angled 45° at handle

Cairns Strip Retractor

Malleable, 203mm long

8 sizes: 6, 8, 10, 11, 13, 16, 19, 25mm

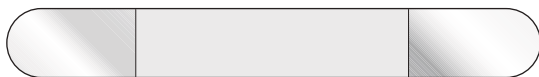

Code	Description
SC-NEU/034a	20 SWG
SC-NEU/034b	18 SWG

O'Connell Retractor

Double ended



Code	Description
SC-NEU/076	216mm long

Cobb Spinal Elevator

13mm wide, knurled handle

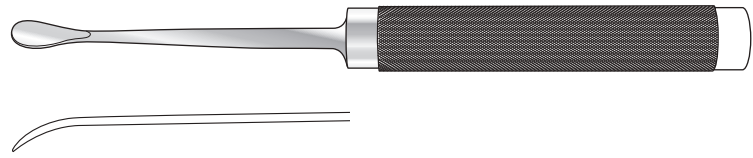

Cobb Spinal Elevator

With blue acetal handles, 279mm long

Code	Description
SC-NEU/073a	10mm wide
SC-NEU/073b	13mm wide
SC-NEU/073c	19mm wide



ALSO AVAILABLE WITH ACETAL SUREGRIP HANDLE
ADD SUFFIX BH TO CATALOGUE NUMBER

Adson Periosteal Elevator

Serrated grip, 165mm long

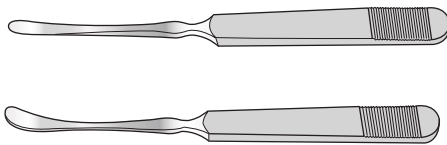

straight

Code	Description
SC-OR/N028	7mm wide

curved

Code	Description
SC-OR/N029	5mm wide
SC-OR/N030	7mm wide

McKissock Spade Periosteal Elevator

Straight



Code	Description
SC-NEU/072	197mm long

Cushing Periosteal Elevator

Slightly curved end



Code	Description
SC-NEU/071	197mm long

Pennybacker Elevator

Curved, sharp, 171mm long

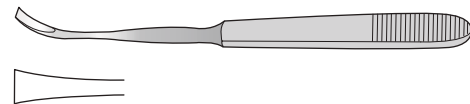

Code	Description
SC-OR/N025	6mm wide

Suction Tubes

Adson Frazier Suction Tube

Angled, fully insulated, 180mm long



Code	Description
SC-NEU/094c	8 F.G.

Retractor Suction Tube

With stilette, 220mm long

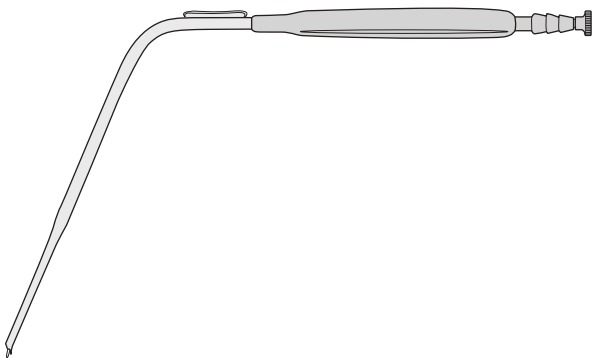

Code	Description
SC-NEU/SK001STIL	Replacement stilette

Frazier Suction Tubes

Malleable, silver, angled, 180mm long

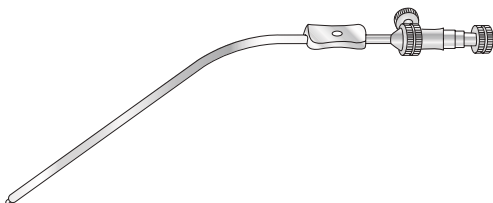

Code	Description
SC-NEU/092a	7 F.G.
SC-NEU/092b	8 F.G.
SC-NEU/092c	9 F.G.

Dandy Rongeur

Straight

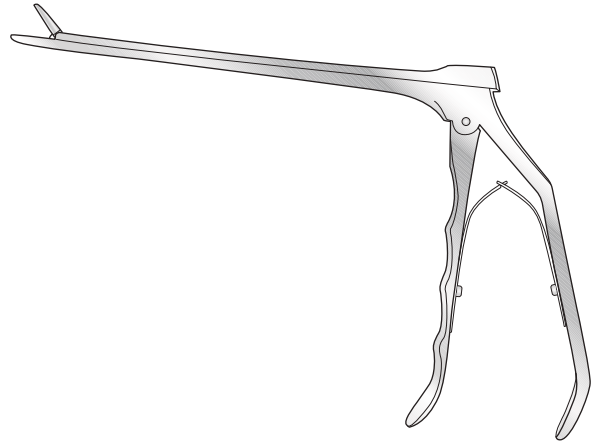

Code	Description
SC-NEU/134	3mm bite, 178mm shaft

Falconer Rongeur

Oblique jaws

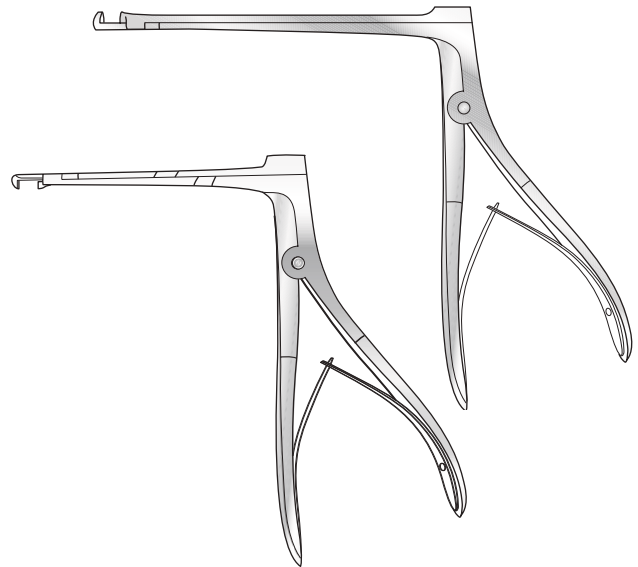

Code	Description
SC-NEU/122a	Upward cutting, 3mm bite, 110mm shaft
SC-NEU/122b	Upward cutting, 5mm bite, 110mm shaft
SC-NEU/122c	Downward cutting, 3mm bite, 85mm shaft
SC-NEU/122d	Downward cutting, 5mm bite, 110mm shaft

Beck Rongeur

Straight, for intervertebral disc

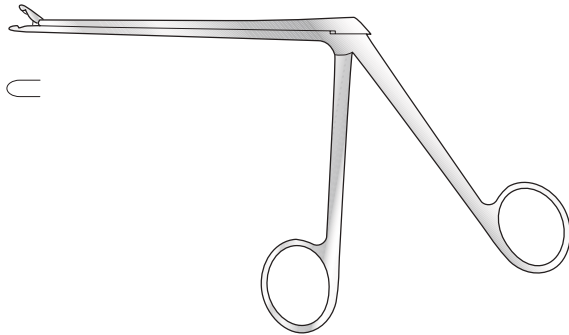

Code	Description
SC-NEU/125	2mm bite, 130mm shaft

Love-Grunwald Rongeur

Cup shaped, jaws 3mm x 10mm, 178mm shaft

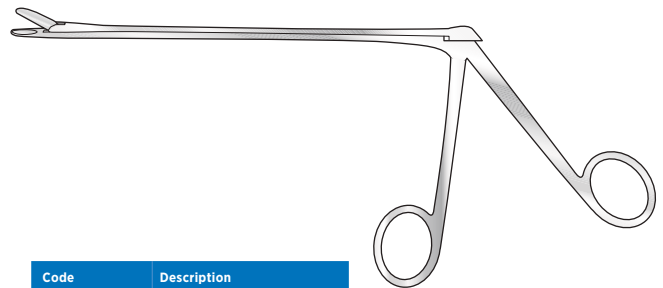

Code	Description
SC-NEU/131a	Straight
SC-NEU/131b	Curved upward
SC-NEU/131c	Curved downward

Cushing Rongeur

130mm shaft

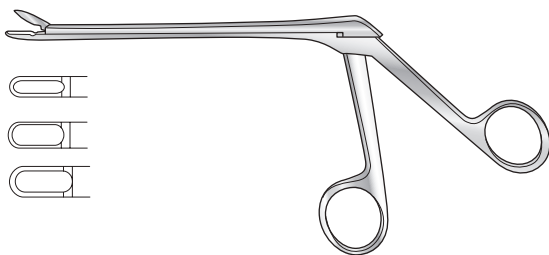

Code	Description
SC-NEU/127-2	2mm bite
SC-NEU/127-3	3mm bite
SC-NEU/127-4	4mm bite
SC-NEU/127-5	5mm bite
SC-NEU/127-6	6mm bite

Mackay Rongeur

140°, straight, 114mm shaft

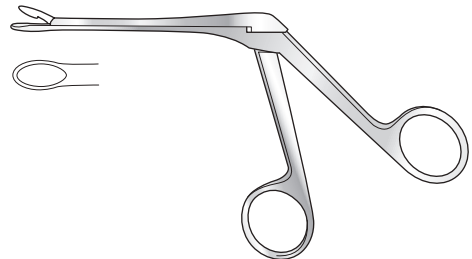

Code	Description
SC-SH/4249	5.5mm

Cushing Rongeur

130mm shaft

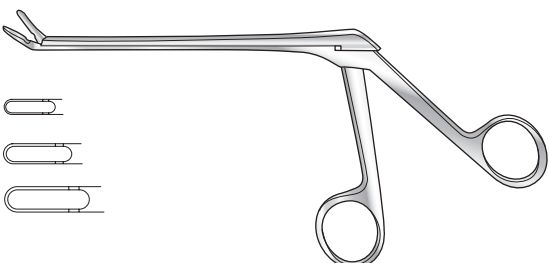

150° upward cutting

Code	Description
SC-NEU/128c	2mm bite
SC-NEU/128	3mm bite
SC-NEU/128a	4mm bite
SC-NEU/128b	5mm bite

150° downward cutting

Code	Description
SC-NEU/130c	2mm bite
SC-NEU/130	3mm bite
SC-NEU/130a	4mm bite
SC-NEU/130b	5mm bite

Northfield Rongeur

Curved, upward cutting

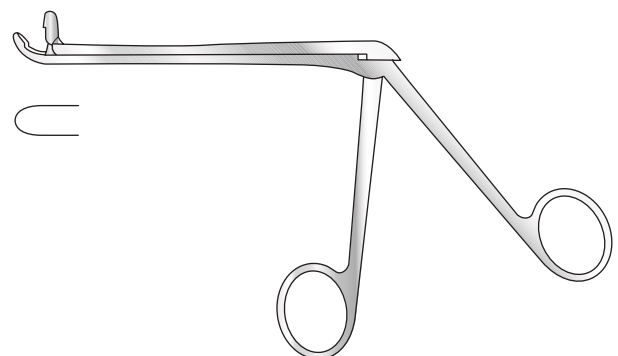

Code	Description
SC-NEU/132	4mm bite, 133mm shaft

Rongeurs

Pennybacker Rongeur

120mm shaft

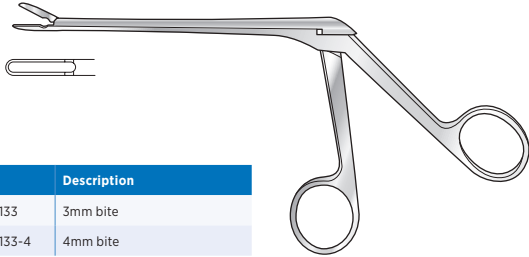

Code	Description
SC-NEU/133	3mm bite
SC-NEU/133-4	4mm bite

Daniel Rongeur

Miniature, for neuropathology

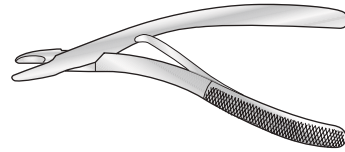

Code	Description
SC-NEU/104	1.5mm bite, 127mm long

St Bart's Rongeur

114mm shaft



Code	Description
SC-ENT/140a	3mm bite

Cairns Rongeur

Fine jaws, angled on flat, serrated jaws, curved handles

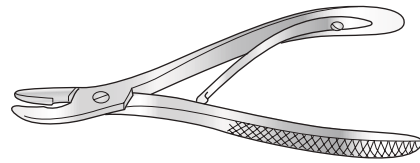

Code	Description
SC-NEU/103	4mm bite 152mm long

St Bart's Rongeur

140°, downward cutting, 114mm shaft

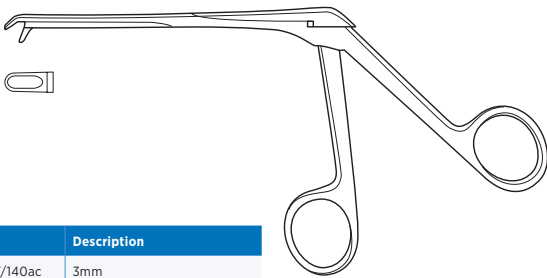

Code	Description
SC-ENT/140ac	3mm

Danish Pattern Rongeur

Angled on flat, fine jaws, curved handles, screw joint

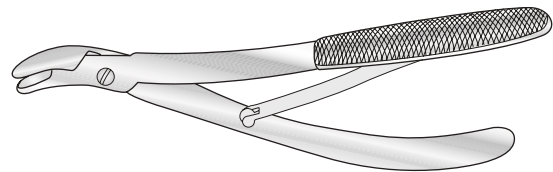

Code	Description
SC-NEU/109	4mm bite, 203mm long

St Bart's Rongeur

140°, upward cutting, 114mm shaft

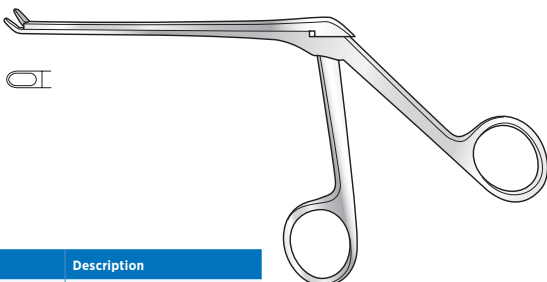

Code	Description
SC-ENT/140b	3mm

Falconer Rongeur

Angled to side, light, screw joint

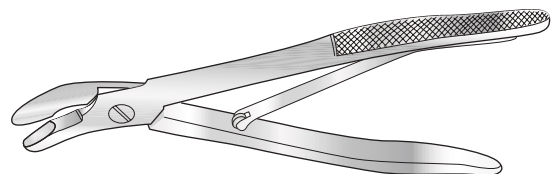

Code	Description
SC-NEU/110	6mm bite, 203mm long

Wilms Rongeur

Angled on flat, narrow jaws

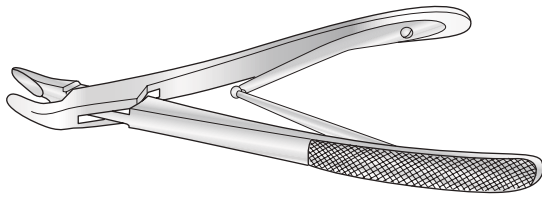

Code	Description
SC-NEU/114	4mm bite, 203mm long

Pennybacker Rongeur

Straight, fine jaws, 203mm long

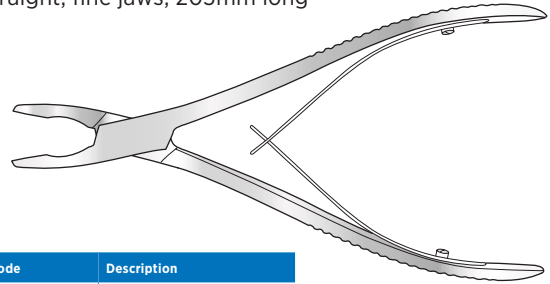

Code	Description
SC-NEU/107	4mm bite

Glasgow Pattern Rongeur

Slightly curved on flat, screw joint

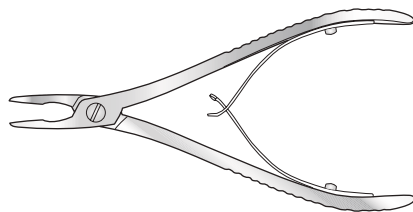

Code	Description
SC-NEU/111	4mm bite, 146mm long

Northfield Rongeur

Straight, 10mm bite

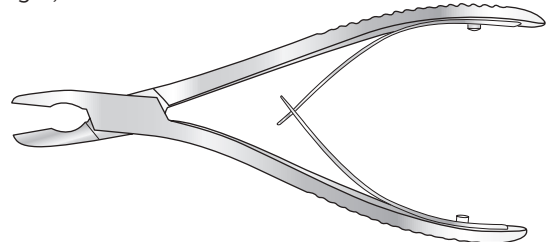

Code	Description
SC-NEU/106	One shallow blade, 200mm long

Heanley Rongeur

Long fine straight jaws, screw joint

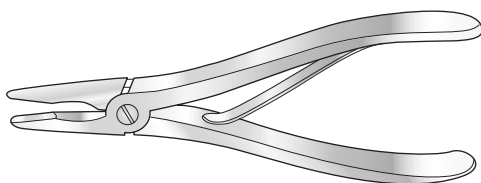

Code	Description
SC-NEU/112	4mm bite, 178mm long

Stokey Rongeur

Angled to side, fine jaws

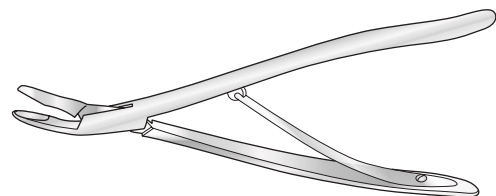

Code	Description
SC-NEU/108	3mm bite, 178mm long

Jansen Rongeur

Short curve, screw joint

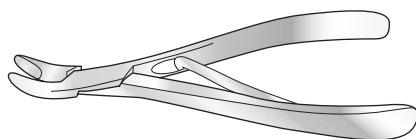

Code	Description
SC-NEU/105	8mm bite, 152mm long

Trotter Rongeur

Angled to side, strong, screw joint

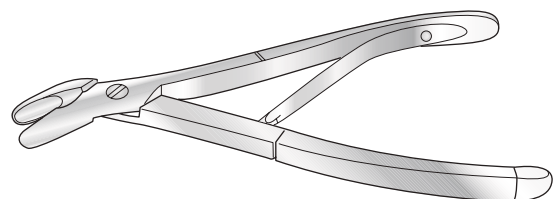

Code	Description
SC-NEU/113	10mm bite, 203mm long

Rongeurs

Luer-Jansen Rongeur

Light, curved on flat, compound action

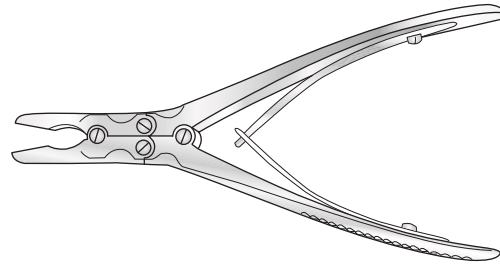
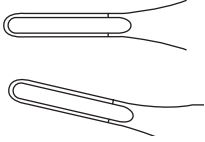

Code	Description
SC-NEU/116	4mm bite, 197mm long

Olivecrona Rongeur

Angled to side, compound action, 229mm long

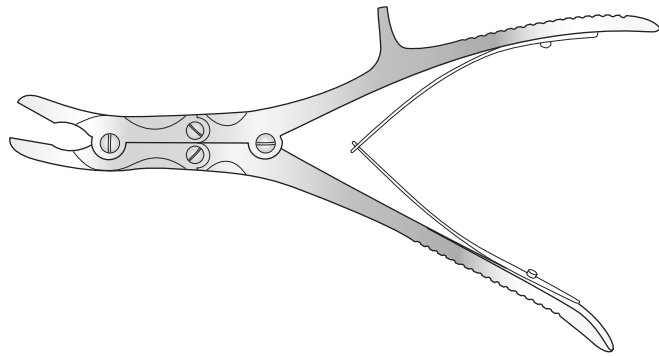

Code	Description
SC-NEU/119a	5mm bite
SC-NEU/119b	6mm bite

Ruskin Rongeur

Curved on flat, compound action

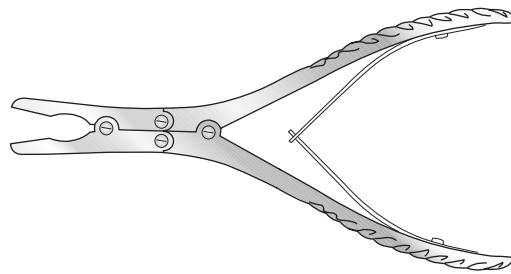

Code	Description
SC-NEU/118	6mm bite, 184mm long

Leksell Rongeur

Curved to side, compound action

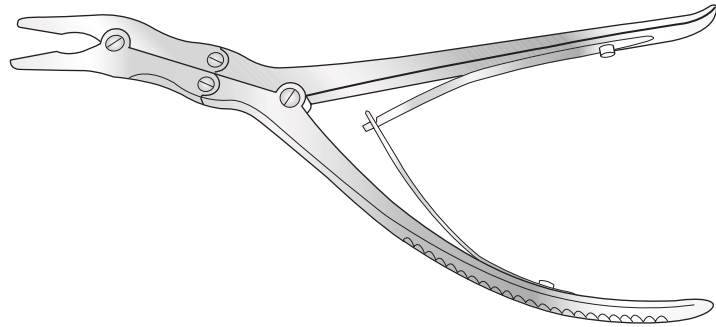
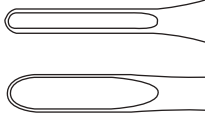

Code	Description
SC-NEU/115a	Small, 6mm bite, 229mm long
SC-NEU/115b	Large, 8mm bite, 254mm long

Luer Stille Bone Rongeur

Curved, 250mm long

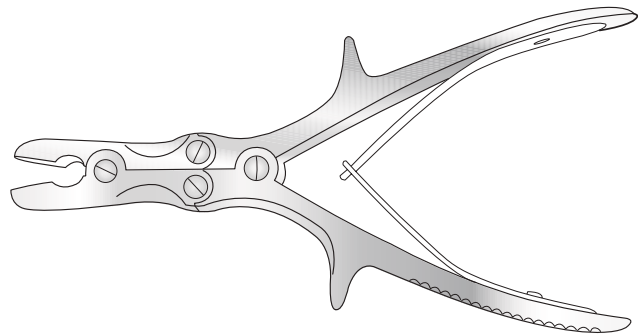
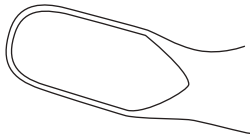

Code	Description
SC-OR/071b	11mm bite
SC-NEU/117	Heavy, 229mm long

Swedish Pattern Laminectomy Shears

Double crank, compound action

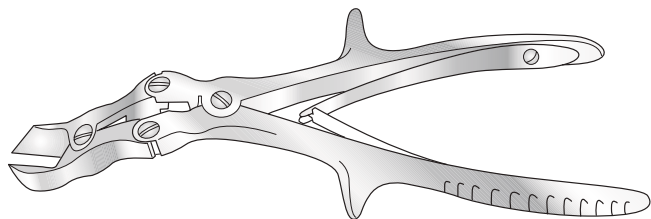

Code	Description
SC-NEU/121	267mm long

Rongeurs

Kerrison Rongeurs

Cloward disc punch (not illustrated)
130° upward cutting, 190mm long

BLACK CERAMIC COATED KERRISONS AVAILABLE
PLEASE ADD SUFFIX -BK WHEN ORDERING

Code	Description
SC-NEU/CL002	2mm wide
SC-NEU/CL003	3mm wide
SC-NEU/CL004	4mm wide
SC-NEU/CL005	5mm wide
SC-NEU/CL006	6mm wide



Kerrison punch

1mm □ 2mm □ 3mm □ 4mm □ 5mm □

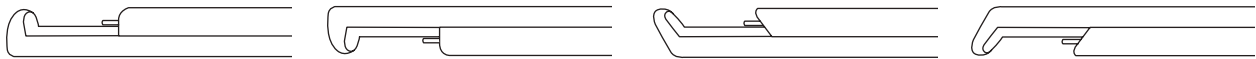

Non-Detachable

90° upward cutting

Code	Description
SC-NEU/136	180mm(L) x 1mm(W)
SC-NEU/137	180mm(L) x 2mm(W)
SC-NEU/138	180mm(L) x 3mm(W)
SC-NEU/139	180mm(L) x 4mm(W)
SC-NEU/140	180mm(L) x 5mm(W)
SC-NEU/141	230mm(L) x 2mm(W)
SC-NEU/142	230mm(L) x 3mm(W)
SC-NEU/143	230mm(L) x 4mm(W)
SC-NEU/144	230mm(L) x 5mm(W)

90° downward cutting

Code	Description
SC-NEU/154	180mm(L) x 1mm(W)
SC-NEU/155	180mm(L) x 2mm(W)
SC-NEU/156	180mm(L) x 3mm(W)
SC-NEU/157	180mm(L) x 4mm(W)
SC-NEU/158	180mm(L) x 5mm(W)
SC-NEU/159	230mm(L) x 2mm(W)
SC-NEU/160	230mm(L) x 3mm(W)
SC-NEU/161	230mm(L) x 4mm(W)
SC-NEU/162	230mm(L) x 5mm(W)

130° upward cutting

Code	Description
SC-NEU/172	180mm(L) x 1mm(W)
SC-NEU/173	180mm(L) x 2mm(W)
SC-NEU/174	180mm(L) x 3mm(W)
SC-NEU/175	180mm(L) x 4mm(W)
SC-NEU/176	180mm(L) x 5mm(W)
SC-NEU/177	200mm(L) x 3mm(W)
SC-NEU/178	200mm(L) x 4mm(W)
SC-NEU/179	200mm(L) x 5mm(W)
SC-NEU/180	200mm(L) x 6mm(W)
SC-NEU/181	230mm(L) x 2mm(W)
SC-NEU/182	230mm(L) x 3mm(W)
SC-NEU/183	230mm(L) x 4mm(W)
SC-NEU/184	230mm(L) x 5mm(W)

130° downward cutting

Code	Description
SC-NEU/198	180mm(L) x 1mm(W)
SC-NEU/199	180mm(L) x 2mm(W)
SC-NEU/200	180mm(L) x 3mm(W)
SC-NEU/201	180mm(L) x 4mm(W)
SC-NEU/202	180mm(L) x 5mm(W)
SC-NEU/203	230mm(L) x 2mm(W)
SC-NEU/204	230mm(L) x 3mm(W)
SC-NEU/205	230mm(L) x 4mm(W)
SC-NEU/206	230mm(L) x 5mm(W)

Detachable

90° upward cutting

Code	Description
SC-NEU/145	180(L) x 1mm(W)
SC-NEU/146	180(L) x 2mm(W)
SC-NEU/147	180(L) x 3mm(W)
SC-NEU/148	180(L) x 4mm(W)
SC-NEU/149	180(L) x 5mm(W)
SC-NEU/150	230(L) x 2mm(W)
SC-NEU/151	230(L) x 3mm(W)
SC-NEU/152	230(L) x 4mm(W)
SC-NEU/153	230(L) x 5mm(W)

90° downward cutting

Code	Description
SC-NEU/163	180(L) x 1mm(W)
SC-NEU/164	180(L) x 2mm(W)
SC-NEU/165	180(L) x 3mm(W)
SC-NEU/166	180(L) x 4mm(W)
SC-NEU/167	180(L) x 5mm(W)
SC-NEU/168	230(L) x 2mm(W)
SC-NEU/169	230(L) x 3mm(W)
SC-NEU/170	230(L) x 4mm(W)
SC-NEU/171	230(L) x 5mm(W)

130° upward cutting

Code	Description
SC-NEU/185	180(L) x 1mm(W)
SC-NEU/186	180(L) x 2mm(W)
SC-NEU/187	180(L) x 3mm(W)
SC-NEU/188	180(L) x 4mm(W)
SC-NEU/189	180(L) x 5mm(W)
SC-NEU/190	200(L) x 3mm(W)
SC-NEU/191	200(L) x 4mm(W)
SC-NEU/192	200(L) x 5mm(W)
SC-NEU/193	200(L) x 6mm(W)
SC-NEU/194	230(L) x 2mm(W)
SC-NEU/195	230(L) x 3mm(W)
SC-NEU/196	230(L) x 4mm(W)
SC-NEU/197	230(L) x 5mm(W)

130° downward cutting

Code	Description
SC-NEU/207	180(L) x 1mm(W)
SC-NEU/208	180(L) x 2mm(W)
SC-NEU/209	180(L) x 3mm(W)
SC-NEU/210	180(L) x 4mm(W)
SC-NEU/211	180(L) x 5mm(W)
SC-NEU/212	230(L) x 2mm(W)
SC-NEU/213	230(L) x 3mm(W)
SC-NEU/214	230(L) x 4mm(W)
SC-NEU/215	230(L) x 5mm(W)

Symmetry Sharp Kerrison®

Your biggest Kerrison challenges solved with one product:

- Productive bite every time
- Never have to use a dull Kerrison again
- Minimise the risk of dural tears
- Reduce hand and arm fatigue
- Easily opened for cleaning
- No need to open multiple trays

Contact us for more details info@surgicalholdings.co.uk

Four sizes of single-use 2" tips:
1mm, 2mm, 3mm and 4mm

Reusable handles come in 5", 6" and 7" sizes for 7", 8" and 9" overall lengths

Locking mechanisms securely hold detachable tips in place

symmetry surgical
authorised distributor



TriMed Technologies

Customise Surgical Solution & Instruments

4/E-1, Second Floor, Nuchana Tower,

Alaknanda Shopping Complex, Alaknanda, New Delhi - 110019 (INDIA)

Ph:- +91-11-41051188, Mobile:-+91-8459130431

Email: trimedtechnologies@gmail.com, info@trimed.co.in

Web: www.trimed.co.in