



TriMed



Laparoscopy Instruments



**ISO & CE Certification
For More Reliability...**



Quality Policy

"We are committed to provide a better quality product which suits the customer requirements & keep on improving resource utilization to best of our efforts"

Content:

GENERAL-THORACIC SURGERY	
Reusable Laparoscopy Instrument.....	1-16
Single Port Laparoscopy Instrument.....	17-18
Pediatric Laparoscopy Instrument.....	18
Small Incision Surgical Instruments.....	19
Disposable Laparoscopy Instruments.....	20-22
Thoracoscopy Instrument.....	23-24
GYNECOLOGY	
Uterus Apparatus.....	25-26
Gynecology Instruments.....	27
Hysteroscopy.....	28-29
Morcellator.....	30-31
ENT	
Sinuscopy Instrument.....	32
Pedestal Laryngoscopy.....	33
Otoscope Instrument.....	33
Bronchoscopy instrument.....	34
Shaver (for ENT).....	34
UROLOGY	
Lithotripsy.....	34
Pelvis Bladder Endoscope.....	35
Resectoscopy (Green Laser).....	35
Cystoscopy.....	35
Urethrotomy.....	36
Resectoscopy.....	36
Electrosurgical Unit.....	37
Ureterorenoscopy.....	37
THYROID INSTRUMENTS.....	37
ORTHOPAEDIC	
Arthroscopy Instrument.....	38
Diskoscopy Instrument.....	39
ANORECTAL	
Sigmoidoscopy.....	39
Esophagoscopy.....	40
BEAUTY INSTRUMENT.....	40
ENDOSCOPE.....	41-42
EQUIPMENT.....	43
ACCESSORIES.....	44

STANDARD HANDLE INSTRUMENT

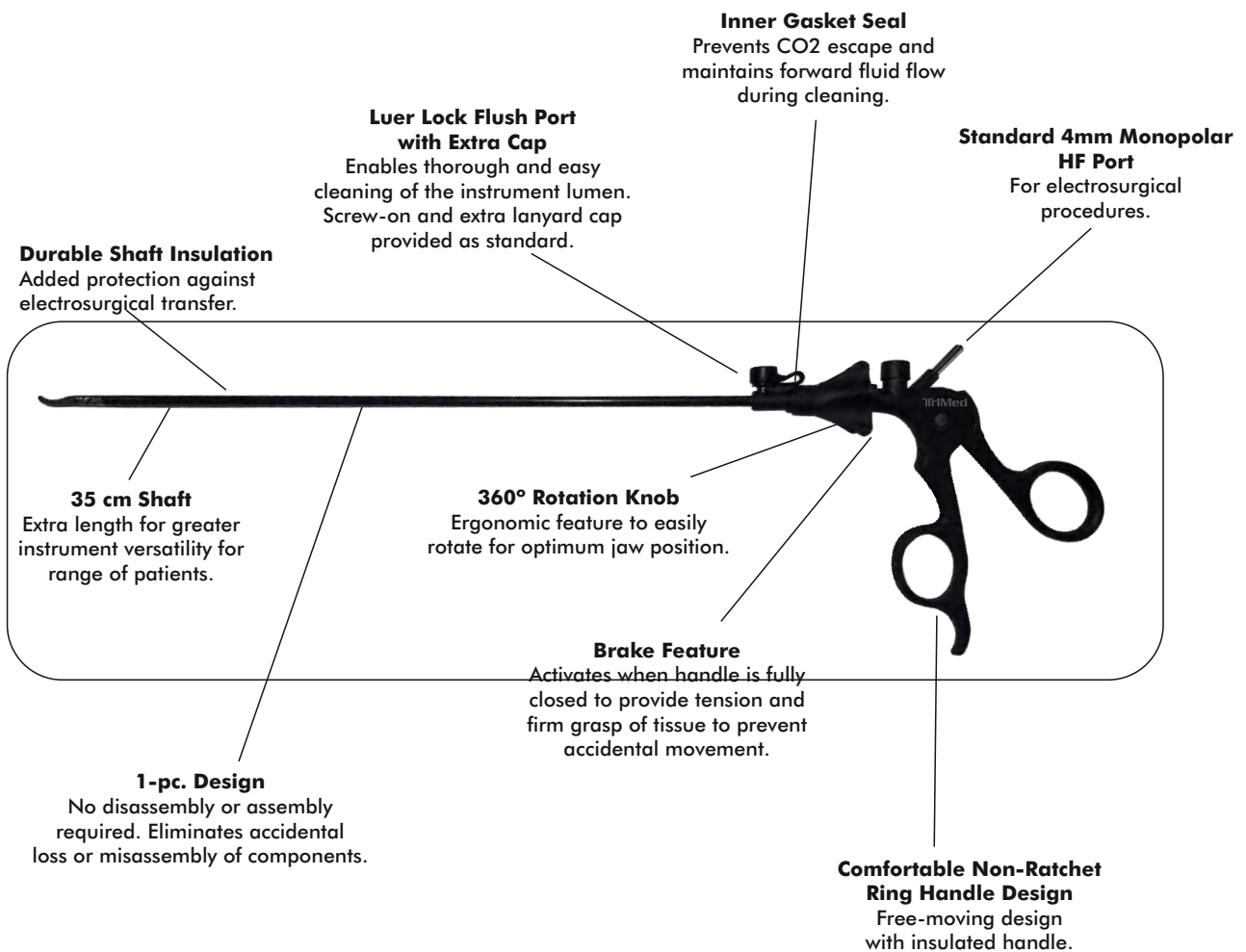



RATCHET HANDLE INSTRUMENT

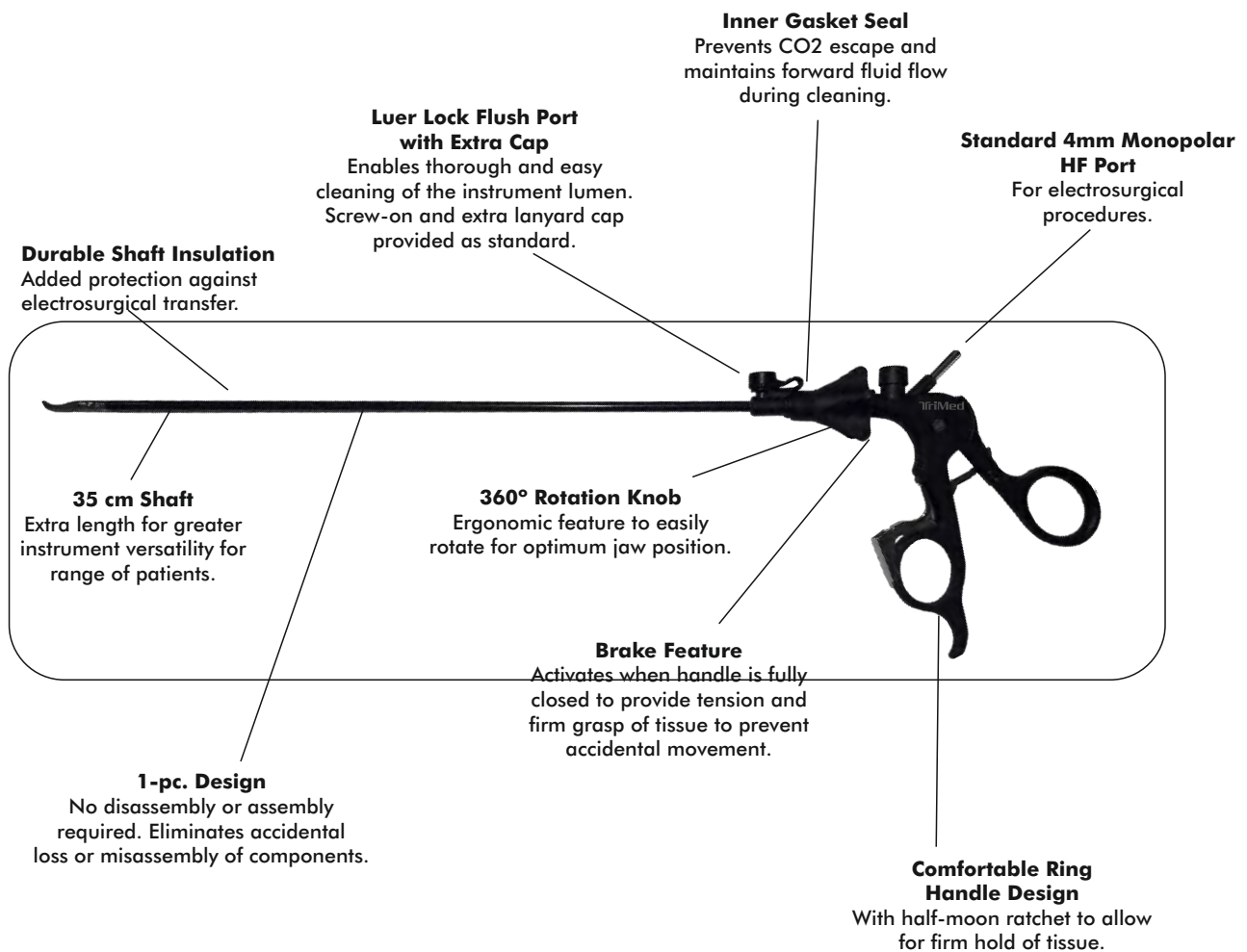



2.8mm & 5mm Forceps

Reusable Laparoscopy Instrument

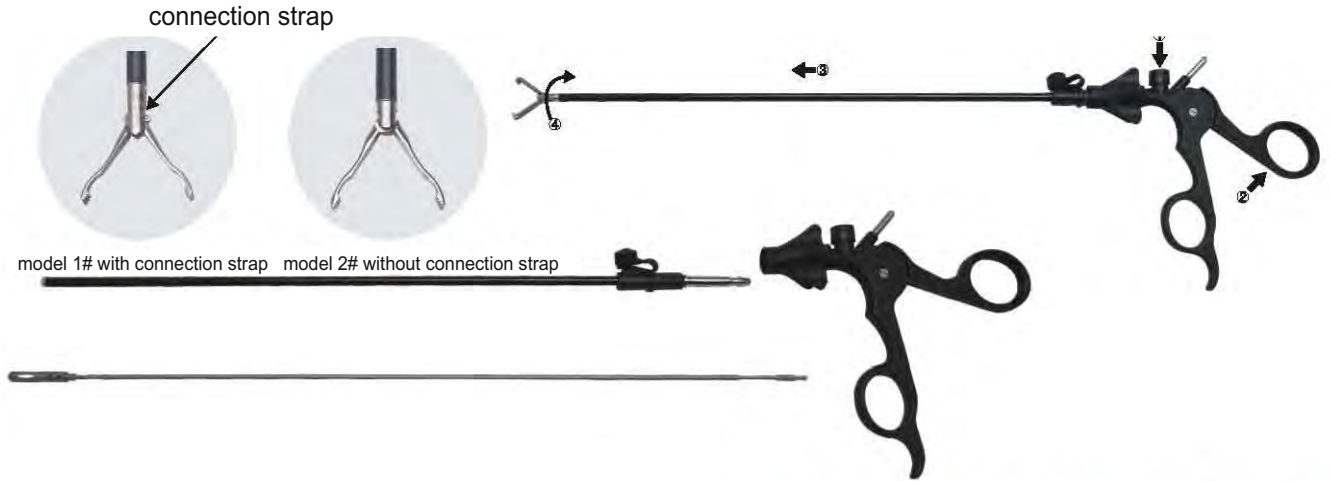

Tips	Code	Tip Length				Handle A	Handle B	Handle C	Handle D
		5mm 200mm	5mm 330mm	5mm 440mm	2.8mm 300mm				
 16mm	S401-251	Scissor, straight, single action	•	•	•				
 21mm	S401-253	Scissor, straight, double action	•	•	•				
 20mm	S401-254	Scissor, curved, single action	•	•	•				
 21mm	S401-256	Scissor, curved, double action	•	•	•				
 14mm	S401-258	Hook scissors	•	•	•				
 15mm	S401-259	Micro scissors	•	•	•				
 23mm	S401-261	Dissector, straight	•	•	•				
 23mm	S401-262	Maryland forceps, 30°	•	•	•				
 25mm	S401-263	Maryland forceps, 45°	•	•	•				
 19mm	S401-262B	Maryland forceps, short	•	•	•				



2.8mm & 5mm Forceps



Tips	Code	Shaft Length				Handle A	Handle B	Handle C	Handle D
		5mm 200mm	5mm 330mm	5mm 440mm	2.8mm 300mm				
 25mm	S401-264	Maryland forceps, 70°				<input checked="" type="checkbox"/>	<input checked="" type="checkbox"/>	<input checked="" type="checkbox"/>	<input checked="" type="checkbox"/>
 25mm	S401-265	Mixer				<input checked="" type="checkbox"/>	<input type="checkbox"/>	<input checked="" type="checkbox"/>	<input type="checkbox"/>
 28mm	S401-262-2	KELLY dissect forceps				<input checked="" type="checkbox"/>	<input type="checkbox"/>	<input checked="" type="checkbox"/>	<input type="checkbox"/>
 23mm	S401-382	Claw forceps				<input checked="" type="checkbox"/>	<input checked="" type="checkbox"/>	<input type="checkbox"/>	<input checked="" type="checkbox"/>
 25mm	S401-266	Atraumatic forceps				<input checked="" type="checkbox"/>	<input checked="" type="checkbox"/>	<input type="checkbox"/>	<input checked="" type="checkbox"/>
 18mm	S401-112	Biopsy forceps				<input checked="" type="checkbox"/>	<input type="checkbox"/>	<input checked="" type="checkbox"/>	<input type="checkbox"/>
 18mm	S401-113	Biopsy forceps, with teeth				<input checked="" type="checkbox"/>	<input type="checkbox"/>	<input checked="" type="checkbox"/>	<input type="checkbox"/>
 17mm	S401-115	Punch forceps				<input checked="" type="checkbox"/>	<input type="checkbox"/>	<input checked="" type="checkbox"/>	<input type="checkbox"/>
 25mm	S401-271	Claw forceps, 1x2 greeve teeth				<input checked="" type="checkbox"/>	<input checked="" type="checkbox"/>	<input type="checkbox"/>	<input checked="" type="checkbox"/>
 23mm	S401-271.1	Claw forceps, 2x3 greeve teeth				<input checked="" type="checkbox"/>	<input checked="" type="checkbox"/>	<input type="checkbox"/>	<input checked="" type="checkbox"/>

Reusable Laparoscopy Instrument













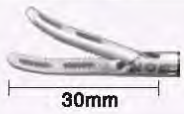

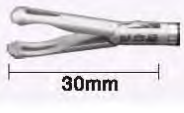

2.8mm & 5mm Forceps

Reusable Laparoscopy Instrument

Tips	Code	5mm 200mm	5mm 330mm	5mm 440mm	2.8mm 300mm	Handle A	Handle B	Handle C	Handle D
	S401-271.2	•	•	•	•				
Claw forceps, 2x4 greeve teeth									
	S401-272B	•	•	•	•		•		•
Claw forceps, 2x3 rough teeth									
	S401-272A	•	•	•			•		•
Claw forceps, 2x4 greeve teeth									
	S401-273	•	•	•	•		•		•
Alligator forceps									
	S401-274	•	•	•	•		•		•
Universal forceps									
	S401-275	•	•	•	•		•		•
Babcock grasper									
	S401-277	•	•	•	•		•		•
Bowel grasper, fenestrated, short									
	S401-278	•	•	•	•		•		•
Oviduct grasper									
	S401-279	•	•	•	•		•		•
Grasper, V-shaped									
	S401-280	•	•	•	•		•		•
Clinch grasper									
	S401-281	•	•	•	•		•		•
Grasping forceps, duck-mouthed									
	S401-330	•	•	•			•		•
Alligator forceps, single action									
	S401-332A	•	•	•	•		•		•
Stomach grasper									



2.8mm & 5mm Forceps

Tips	Code	5mm 200mm	5mm 330mm	5mm 440mm	2.8mm 300mm	Handle A	Handle B	Handle C	Handle D
 30mm	S401-332B	•	•	•					
 30mm	S401-333	•	•	•	•		•		•
 25mm	S401-334	•	•	•	•		•		•
 21mm	S401-335-2	•	•	•	•		•		•
 22mm	S401-335	•	•	•	•		•		•
 35mm	S401-336	•	•	•	•		•		•
 38mm	S401-337	•	•	•	•		•		•
 36mm	S401-338	•	•	•	•		•		•
 37mm	S401-339	•	•	•	•		•		•
 23mm	S401-278-2	•	•	•	•		•		•
 33mm	S401-281-2	•	•	•	•		•		•
 23mm	S401-385	•	•	•		•		•	
 25mm	S401-386	•	•	•	•	•		•	















2.8mm & 5mm Forceps

Reusable Laparoscopy Instrument

Tips	Code					Handle A	Handle B	Handle C	Handle D
		5mm 200mm	5mm 330mm	5mm 440mm	2.8mm 300mm				
 25mm	S401-387	Knot forceps, B-shaped				<input type="checkbox"/>	<input type="checkbox"/>	<input type="checkbox"/>	<input type="checkbox"/>
 25mm	S401-388	Knot forceps, S-shaped				<input type="checkbox"/>	<input type="checkbox"/>	<input type="checkbox"/>	<input type="checkbox"/>
 26mm	S401-411	Wave grasper, fenestrated				<input type="checkbox"/>	<input type="checkbox"/>	<input type="checkbox"/>	<input type="checkbox"/>
 28mm	S401-397	Alis grasper, horizontal teeth				<input type="checkbox"/>	<input type="checkbox"/>	<input type="checkbox"/>	<input type="checkbox"/>
 28mm	S401-398	Alis grasper, Vertical				<input type="checkbox"/>	<input type="checkbox"/>	<input type="checkbox"/>	<input type="checkbox"/>
 38mm	S401-276	Debaquey grasper				<input type="checkbox"/>	<input type="checkbox"/>	<input type="checkbox"/>	<input type="checkbox"/>
 25mm	S401-390	Cervix grasper				<input type="checkbox"/>	<input type="checkbox"/>	<input type="checkbox"/>	<input type="checkbox"/>
 30mm	S401-392	Atraumatic grasper, with hollow jaws, wavy				<input type="checkbox"/>	<input type="checkbox"/>	<input type="checkbox"/>	<input type="checkbox"/>
 10mm	S401-393	Right angle dissector				<input type="checkbox"/>	<input type="checkbox"/>	<input type="checkbox"/>	<input type="checkbox"/>
 22mm	S401-394	Grasper, to retrieve lost gallstones				<input type="checkbox"/>	<input type="checkbox"/>	<input type="checkbox"/>	<input type="checkbox"/>
 33mm	S401-284-1	Lung grasper				<input type="checkbox"/>	<input type="checkbox"/>	<input type="checkbox"/>	<input type="checkbox"/>
 28mm	S401-395	Grasper Forceps				<input type="checkbox"/>	<input type="checkbox"/>	<input type="checkbox"/>	<input type="checkbox"/>
 28mm	S401-396	Grasper Forceps				<input type="checkbox"/>	<input type="checkbox"/>	<input type="checkbox"/>	<input type="checkbox"/>























10mm Forceps

Tips	Code	10mm 250mm	10mm 330mm	Handle E	Handle F	Handle G	Handle H	Handle I
	S401-368	Mixer	<input type="checkbox"/>	<input type="checkbox"/>	<input type="checkbox"/>	<input type="checkbox"/>	<input type="checkbox"/>	<input type="checkbox"/>
	S401-367	Maryland forceps, small tips	<input type="checkbox"/>	<input type="checkbox"/>	<input type="checkbox"/>	<input type="checkbox"/>	<input type="checkbox"/>	<input type="checkbox"/>
	S401-367.2	Maryland forceps, large tips	<input type="checkbox"/>	<input type="checkbox"/>	<input type="checkbox"/>	<input type="checkbox"/>	<input type="checkbox"/>	<input type="checkbox"/>
	S401-286	Anvil holder forceps	<input type="checkbox"/>	<input type="checkbox"/>	<input type="checkbox"/>	<input type="checkbox"/>	<input type="checkbox"/>	<input type="checkbox"/>
	S401-297	Grams plate grasper	<input type="checkbox"/>	<input type="checkbox"/>	<input type="checkbox"/>	<input type="checkbox"/>	<input type="checkbox"/>	<input type="checkbox"/>
	S401-277-1	Grasper, dolphin nose	<input type="checkbox"/>	<input type="checkbox"/>	<input type="checkbox"/>	<input type="checkbox"/>	<input type="checkbox"/>	<input type="checkbox"/>
	S401-381	Claw forceps, 2x3 teeth	<input type="checkbox"/>	<input type="checkbox"/>	<input type="checkbox"/>	<input type="checkbox"/>	<input type="checkbox"/>	<input type="checkbox"/>
	S401-283	Babcock grasper	<input type="checkbox"/>	<input type="checkbox"/>	<input type="checkbox"/>	<input type="checkbox"/>	<input type="checkbox"/>	<input type="checkbox"/>
	S401-276-2	Broadness mouth grasper	<input type="checkbox"/>	<input type="checkbox"/>	<input type="checkbox"/>	<input type="checkbox"/>	<input type="checkbox"/>	<input type="checkbox"/>
	S401-276-1	Atraumatic grasper	<input type="checkbox"/>	<input type="checkbox"/>	<input type="checkbox"/>	<input type="checkbox"/>	<input type="checkbox"/>	<input type="checkbox"/>
	S401-273-1	Alligator grasper	<input type="checkbox"/>	<input type="checkbox"/>	<input type="checkbox"/>	<input type="checkbox"/>	<input type="checkbox"/>	<input type="checkbox"/>
	S401-399	Suture grasper	<input type="checkbox"/>	<input type="checkbox"/>	<input type="checkbox"/>	<input type="checkbox"/>	<input type="checkbox"/>	<input type="checkbox"/>
	S401-284	Lung grasper	<input type="checkbox"/>	<input type="checkbox"/>	<input type="checkbox"/>	<input type="checkbox"/>	<input type="checkbox"/>	<input type="checkbox"/>
	S401-332C	Stomach Grasper	<input type="checkbox"/>	<input type="checkbox"/>	<input type="checkbox"/>	<input type="checkbox"/>	<input type="checkbox"/>	<input type="checkbox"/>
	S401-368.1	Mixer 90°	<input type="checkbox"/>	<input type="checkbox"/>	<input type="checkbox"/>	<input type="checkbox"/>	<input type="checkbox"/>	<input type="checkbox"/>



10mm Forceps





Reusable Laparoscopy Instrument

Tips	Code	10mm 250mm	10mm 330mm	Handle E	Handle F	Handle G	Handle H	Handle I
	S401-282	Hemostatic forceps						
		<input type="checkbox"/>	<input type="checkbox"/>		<input type="checkbox"/>			
	S401-105	Biopsy forceps				<input type="checkbox"/>		
		<input type="checkbox"/>	<input type="checkbox"/>			<input type="checkbox"/>		
	S401-334-1	Target type forceps						<input type="checkbox"/>
		<input type="checkbox"/>	<input type="checkbox"/>					<input type="checkbox"/>
	S301-111	Lymph gland forceps			<input type="checkbox"/>			
		<input type="checkbox"/>	<input type="checkbox"/>		<input type="checkbox"/>			
	S301-S-11-1	Pulmonary lobe forceps			<input type="checkbox"/>			
		<input type="checkbox"/>	<input type="checkbox"/>		<input type="checkbox"/>			
	S401-376-2	Maryland forceps, articulating					<input type="checkbox"/>	
			<input type="checkbox"/>				<input type="checkbox"/>	
	S302-293	Babcock forceps, articulating					<input type="checkbox"/>	
			<input type="checkbox"/>				<input type="checkbox"/>	
	S401-298	Debakey grasper, articulating					<input type="checkbox"/>	
			<input type="checkbox"/>				<input type="checkbox"/>	
	S401-276-3	Debakey grasper			<input type="checkbox"/>			
		<input type="checkbox"/>	<input type="checkbox"/>		<input type="checkbox"/>			
	S401-279-2	Atraumatic forceps, fenestrated			<input type="checkbox"/>			
		<input type="checkbox"/>	<input type="checkbox"/>		<input type="checkbox"/>			
	S401-383	Scissors, straight		<input type="checkbox"/>				
		<input type="checkbox"/>	<input type="checkbox"/>	<input type="checkbox"/>				
	S401-384	Scissors, curved		<input type="checkbox"/>				
		<input type="checkbox"/>	<input type="checkbox"/>	<input type="checkbox"/>				
	S401-282.2	Intestine grasper			<input type="checkbox"/>			
		<input type="checkbox"/>	<input type="checkbox"/>		<input type="checkbox"/>			
	S401-367.2	Maryland forceps 30°		<input type="checkbox"/>				
		<input type="checkbox"/>	<input type="checkbox"/>	<input type="checkbox"/>				
	S401-367.3	Maryland forceps 45°			<input type="checkbox"/>			
		<input type="checkbox"/>	<input type="checkbox"/>		<input type="checkbox"/>			



Trocar





Trocar, magnetic

	 Magnetic Trocar	S401-619.1 ϕ 3.5x95mm S401-619.2 ϕ 5.5x95mm S401-619.3 ϕ 10.5x95mm S401-619.4 ϕ 13x95mm
	 Magnetic Trocar, with screw	S401-605.1 ϕ 5.5x95mm S401-605.2 ϕ 10.5x95mm
	 Magnetic Trocar, with safety	S401-621.1 ϕ 5.5x95mm S401-621.2 ϕ 10.5x95mm S401-621.3 ϕ 13x95mm
	 Magnetic Trocar, with screw & safety	S401-617.1 ϕ 5.5x95mm S401-617.2 ϕ 10.5x95mm

Trocar, cross

	 Cross Trocar	S401-611.1 ϕ 3.5x95mm S401-611.2 ϕ 5.5x95mm S401-611.3 ϕ 10.5x95mm S401-611.4 ϕ 13x95mm
	 Cross Trocar, with screw	S401-614.1 ϕ 5.5x95mm S401-614.2 ϕ 10.5x95mm
	 Cross Trocar, with safety	S401-603.1 ϕ 5.5x95mm S401-603.2 ϕ 10.5x95mm S401-603.3 ϕ 13x95mm
	 Cross Trocar, with screw & safety	S401-618.1 ϕ 5.5x95mm S401-618.2 ϕ 10.5x95mm

Trocar, spring

	 Spring Trocar	S401-615.2 ϕ 5.5x95mm S401-615.3 ϕ 10.5x95mm S401-615.4 ϕ 13x95mm
	 Spring Trocar, with screw	S401-623.1 ϕ 5.5x95mm S401-623.2 ϕ 10.5x95mm S401-623.3 ϕ 13x95mm
	 Spring Trocar, with safety	S401-616.1 ϕ 5.5x95mm S401-616.2 ϕ 10.5x95mm S401-616.3 ϕ 13x95mm
	 Spring Trocar, with screw & safety	S401-624.1 ϕ 5.5x95mm S401-624.2 ϕ 10.5x95mm S401-624.3 ϕ 13x95mm



Conical Tips, Blunt



Conical Tips, Sharp

TSCS also offer you Trocars with Conical Tips, Blunt and Conical Tips, Sharp as your needed.

Reducer



S401-491 Reducer $\phi 10\text{mm}-\phi 5\text{mm}$



S401-492 Reducer $\phi 10\text{mm}-\phi 5\text{mm}$



S401-493



$\phi 5.5\text{mm}$ S401-804
 $\phi 10.5\text{mm}$ S401-803



$\phi 5.5\text{mm}$ S401-802
 $\phi 10.5\text{mm}$ S401-801



$\phi 5.5\text{mm}$ S401-806
 $\phi 10.5\text{mm}$ S401-805

Small Incision Surgical Instruments



S403-111
L-Shaped Retractor
24x90x190mm



S403-112
S-Shaped Retractor
24x90x220mm

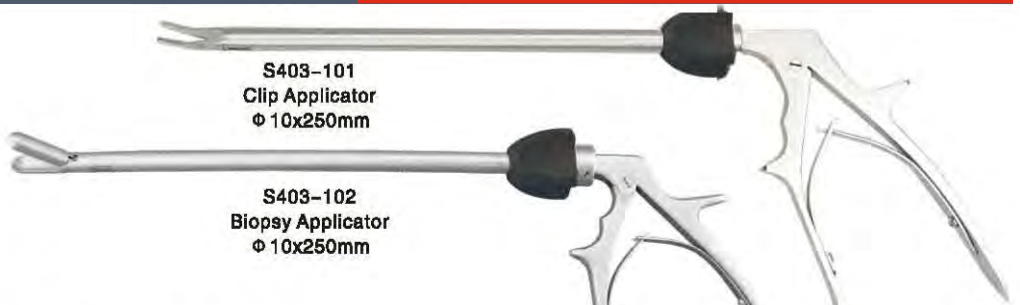

S403-101
Clip Applicator
 $\phi 10 \times 250\text{mm}$

S403-102
Biopsy Applicator
 $\phi 10 \times 250\text{mm}$



S403-105
Curved-Scissors
 $\phi 5 \times 200\text{mm}$



S403-102
Dissecting Forceps
 $\phi 5 \times 200\text{mm}$



S403-103
Dissecting Forceps
 $\phi 5 \times 200\text{mm}$



S403-104
Curved-Scissors
 $\phi 5 \times 200\text{mm}$



S403-105
Straight-Scissors
 $\phi 5 \times 200\text{mm}$



S403-109
Hook-Electrode
 $\phi 5 \times 200\text{mm}$



S403-110
Ballpoint-Electrode
 $\phi 5 \times 200\text{mm}$

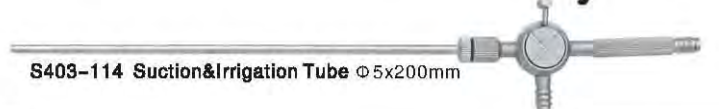

S403-114 Suction & Irrigation Tube $\phi 5 \times 200\text{mm}$



S403-115
Movable Retractor

S403-116
Appendix Retractor



S403-118 Bile Duct Needle

S403-118.1 Bile Duct Needle



S403-117
Prop Opening Apparatus

Bile Duct Puncture Needle

- S401-285 Tips $\phi 0.8\text{mm}$
- S401-285.1 Tips $\phi 1.0\text{mm}$
- S401-285.2 Tips $\phi 1.2\text{mm}$
- S401-285.3 Tips $\phi 1.5\text{mm}$
- S401-285.4 Tips $\phi 1.8\text{mm}$
- S401-285.5 Tips $\phi 2.0\text{mm}$
- S401-285.6 Tips $\phi 2.2\text{mm}$



$\phi 5 \times 330\text{mm}$



Needle Holder

Mode O $\phi 5 \times 330 \text{mm}$

- S401-341 Needle holder, straight
- S401-341 .1 Needle holder, curved
- S401-341 .2 Needle holder, automatic resetting
- S401-341 .3 Needle holder, multi-function

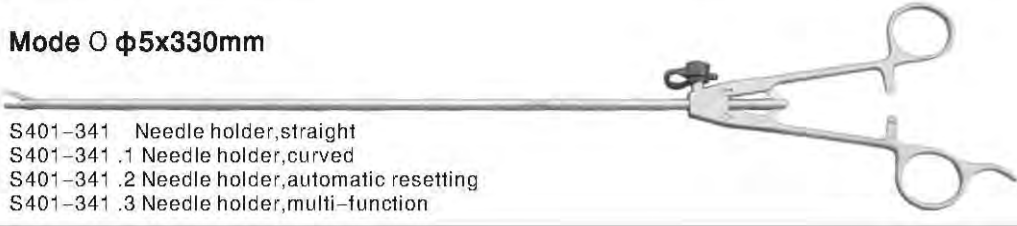

Mode V $\phi 5 \times 330 \text{mm}$

- S401-342 Needle holder, straight
- S401-342 .1 Needle holder, curved
- S401-342 .2 Needle holder, automatic resetting
- S401-342 .3 Needle holder, multi-function

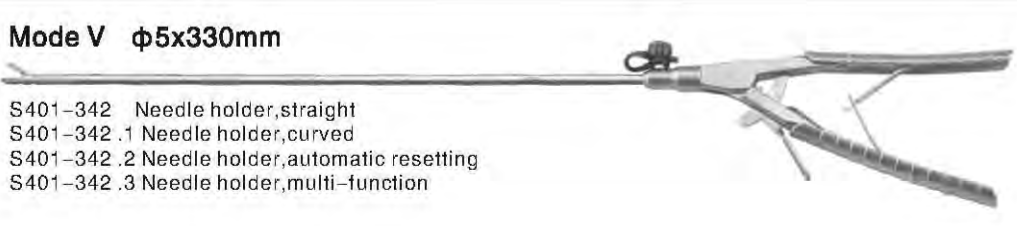

Mode V1 $\phi 5 \times 330 \text{mm}$

- S401-343 Needle holder, straight
- S401-343 .1 Needle holder, curved
- S401-343 .2 Needle holder, automatic resetting
- S401-343 .3 Needle holder, multi-function

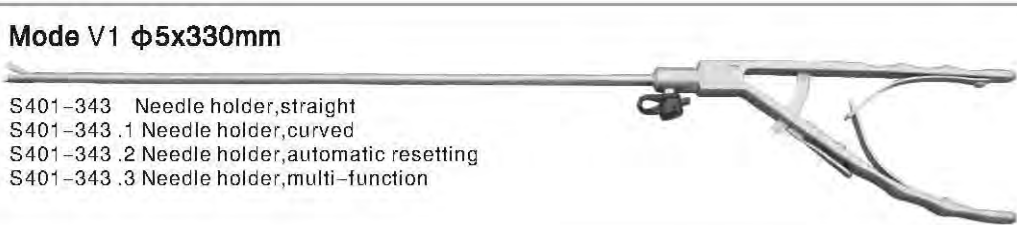

Mode V2 $\phi 5 \times 330 \text{mm}$

- S401-344 Needle holder, straight
- S401-344 .1 Needle holder, curved
- S401-344 .2 Needle holder, automatic resetting
- S401-344 .3 Needle holder, multi-function

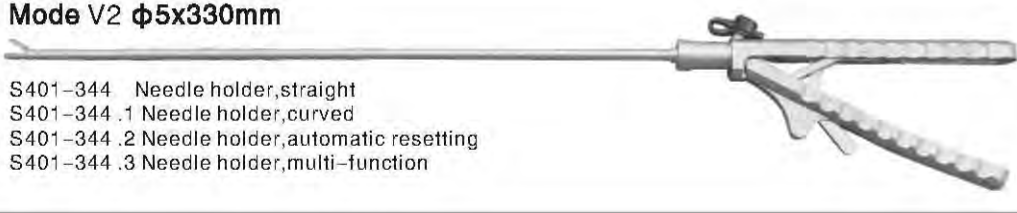

Mode Pistol $\phi 5 \times 330 \text{mm}$

- S401-345 Needle holder, straight
- S401-345 .1 Needle holder, curved
- S401-345 .2 Needle holder, automatic resetting
- S401-345 .3 Needle holder, multi-function

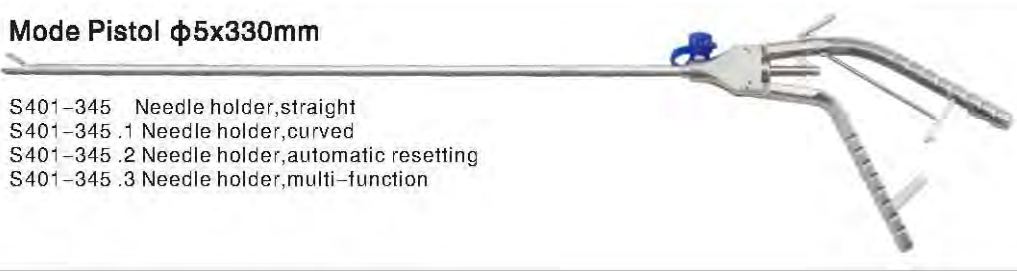

Mode A $\phi 5 \times 330 \text{mm}$

- S401-346 Needle holder, straight
- S401-346 .1 Needle holder, curved
- S401-346 .2 Needle holder, automatic resetting
- S401-346 .3 Needle holder, multi-function

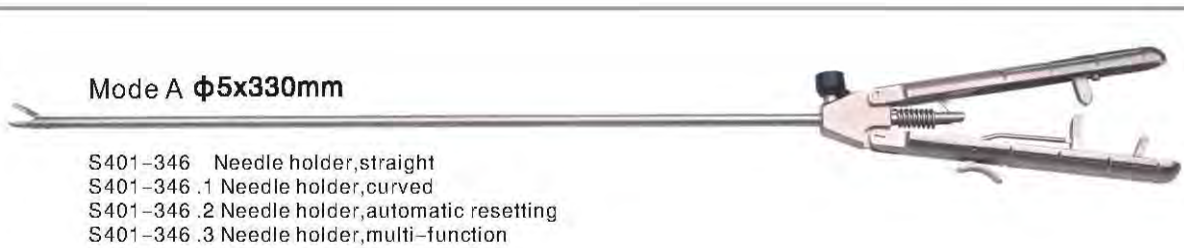

Straight



Curved



Automatic resetting



Muti-function



Clip Applicator

Reusable Laparoscopy Instrument



Hem-O-Lok

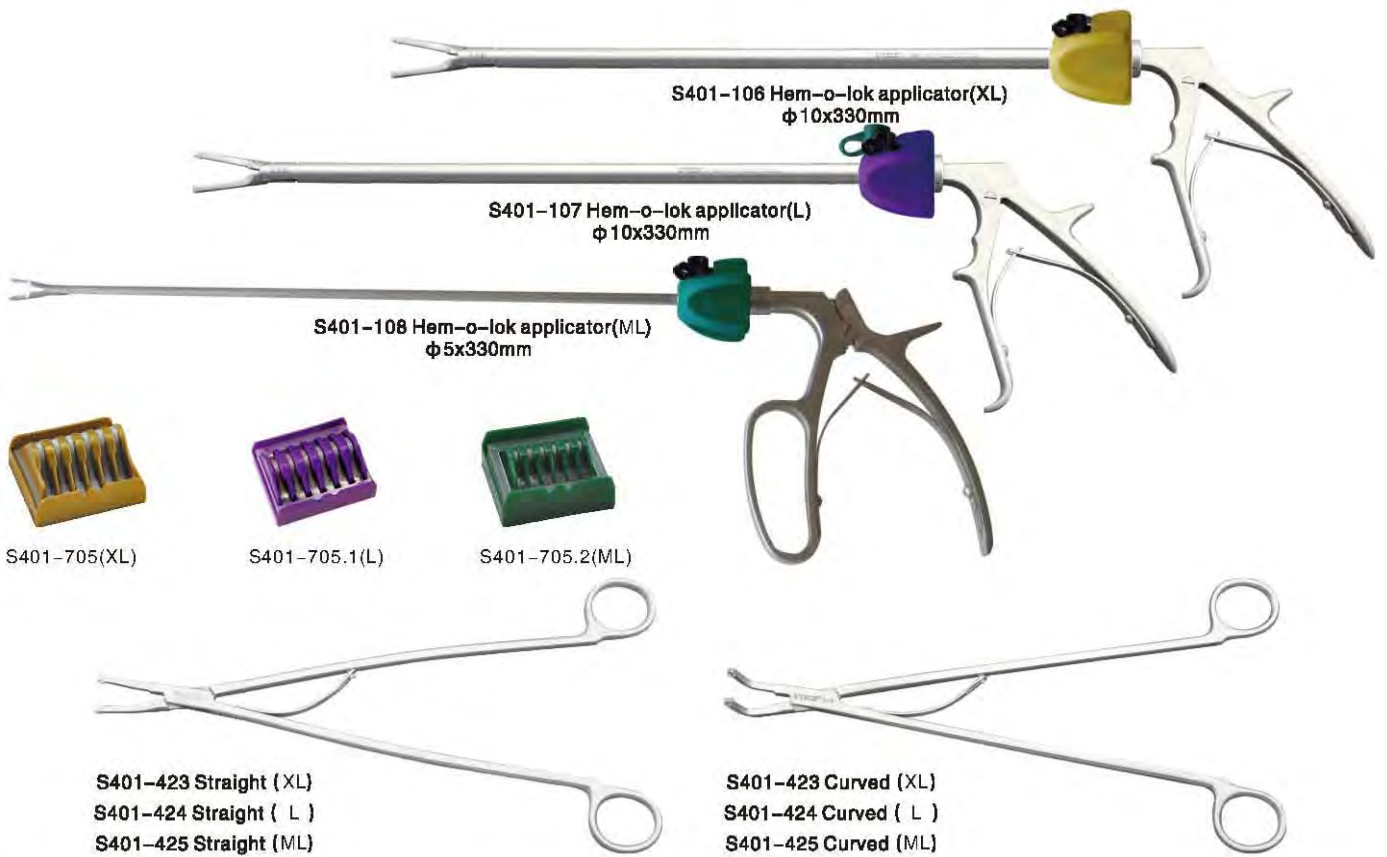

Clip Remover





Clip Applicator

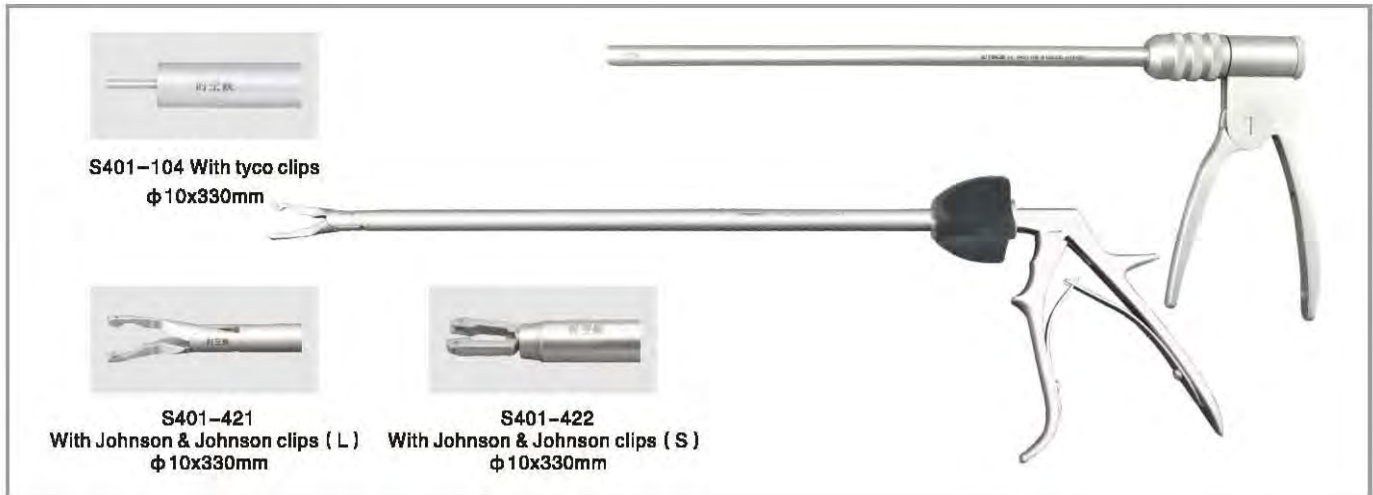

Bulldog Forceps

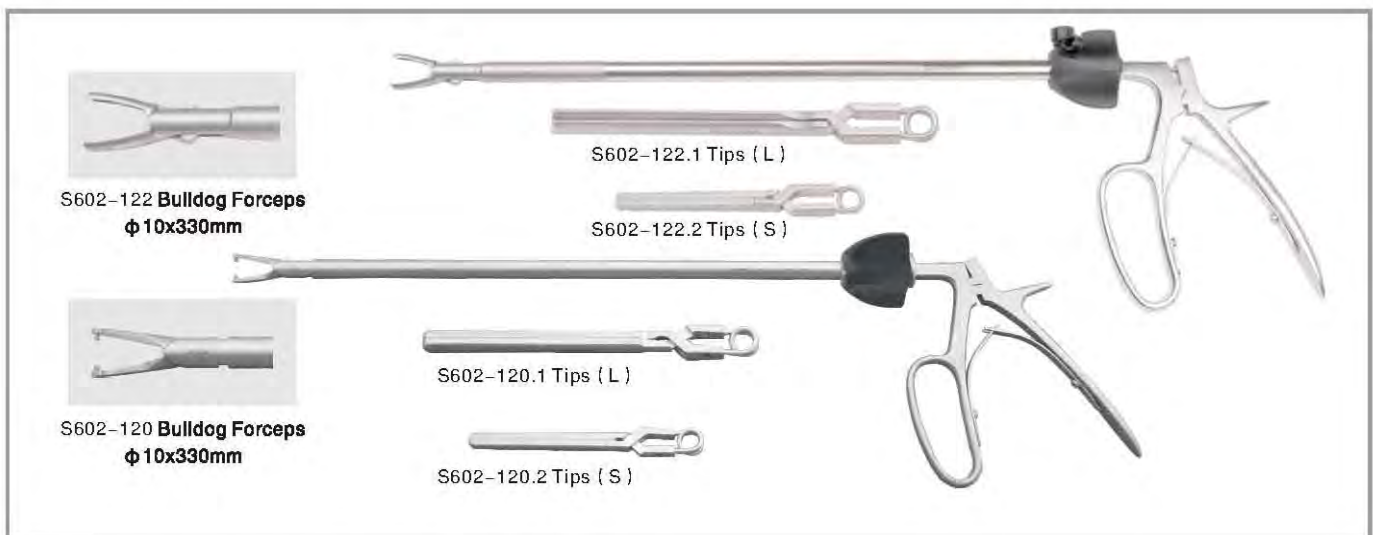

Veress Needle



Spring Forceps



Reusable Laparoscopy Instrument



Articulating Instruments

Reusable Laparoscopy Instrument

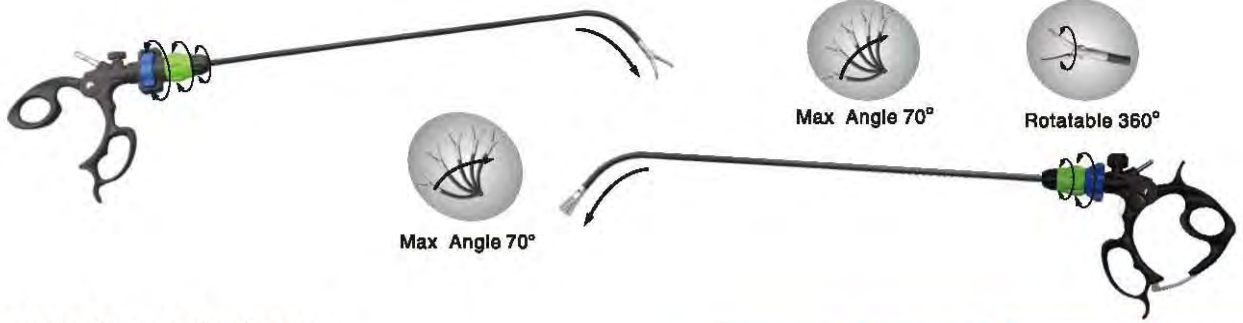

Monopolar forceps&scissors

Tips	Code	5mm 350mm	5mm 400mm	Single 360°	Double 360°	Handle A	Handle B	Handle C	Handle D
	S407-256	•	•	•	•	•	•	•	•
	S407-262	•	•	•	•	•	•	•	•
	S407-264	•	•	•	•	•	•	•	•
	S407-281	•	•	•	•	•	•	•	•
	S407-280	•	•	•	•	•	•	•	•
	S407-275	•	•	•	•	•	•	•	•
	S407-265	•	•	•	•	•	•	•	•
	S407-271	•	•	•	•	•	•	•	•
	S407-398	•	•	•	•	•	•	•	•
	S407-336	•	•	•	•	•	•	•	•

Bipolar coagulation forceps

Tips	Code	5mm 350mm	5mm 400mm	Single 360°	Double 360°	Handle A	Handle B	Handle C	Handle D
	S407-538	•	•	•	•	•	•	•	•
	S407-536	•	•	•	•	•	•	•	•
	S407-537	•	•	•	•	•	•	•	•
	S407-535	•	•	•	•	•	•	•	•



Articulating Electrodes



Bipolar Coagulation Forceps



Reusable Laparoscopy Instrument



Monopolar Electrode



Monopolar Cable



Cholangiography Forceps



Stone Forceps For Bile Duct



Bile Duct Knife





Hernia Repair Instrument

Reusable Laparoscopy Instrument



S401-712
Blunt
Φ2.5x250mm



S401-713
Sharp
Φ2.5x250mm



S401-710

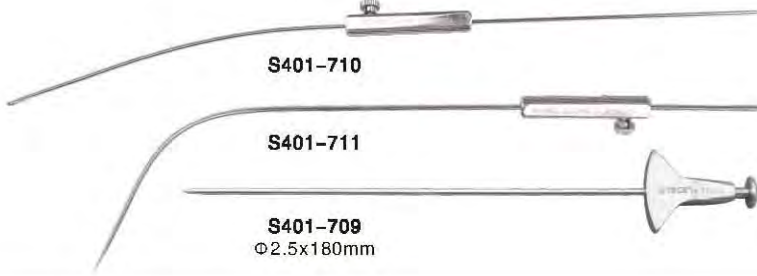

S401-711

S401-709
Φ2.5x180mm



Φ2.5x200mm

Golden Finger



S401-429(S)



S401-427(L)



S401-428(M)

Suction & Irrigation Tube

S401-464 Pistol type



Φ5/10x330mm

S401-461 Push type Φ5x330mm



S401-463 Press type Φ5x330mm



S401-461.1 Φ10x330mm



S401-461.2 Φ10x330mm



S401-461.3 Φ5x330mm





Ligature Probe

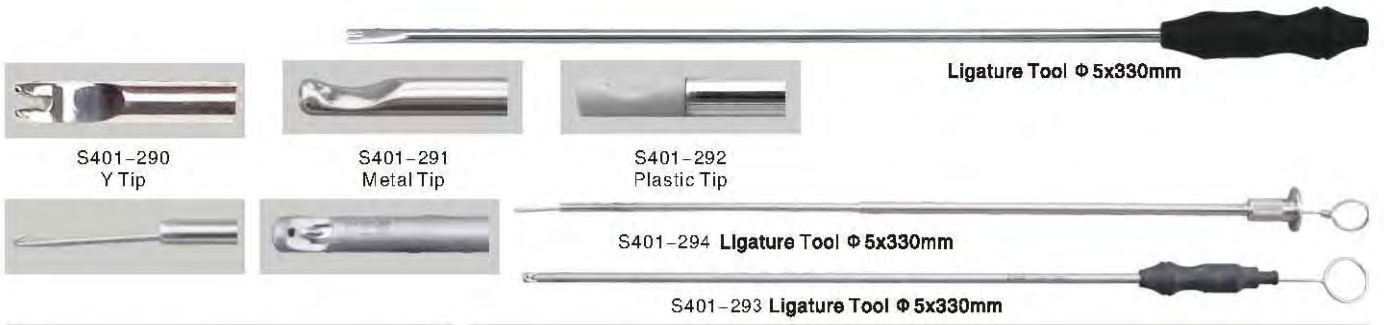

Single Port Laparoscopy

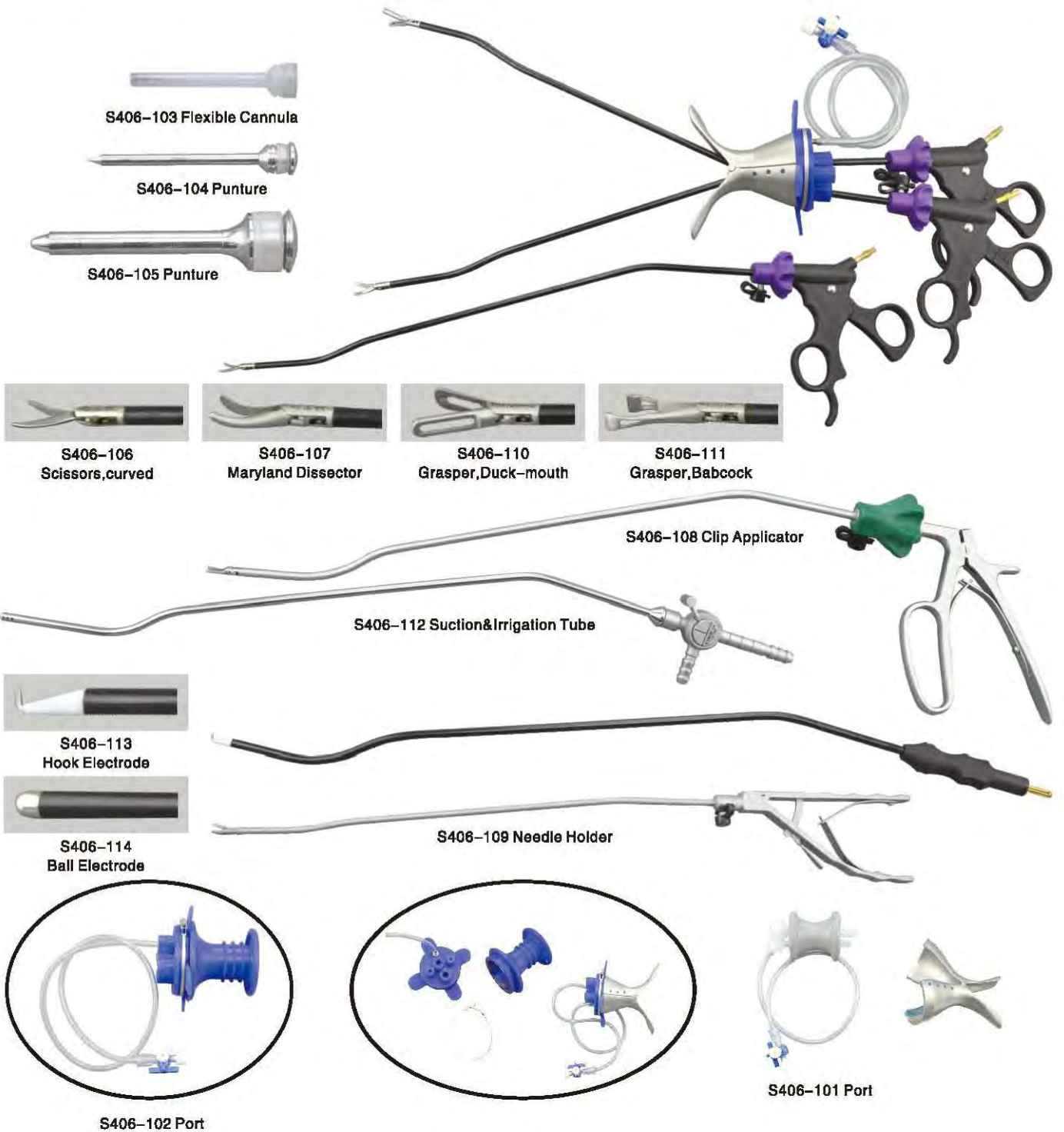

Single Port Laparoscopy Instrument



Suspensory Laparoscopic Instrument

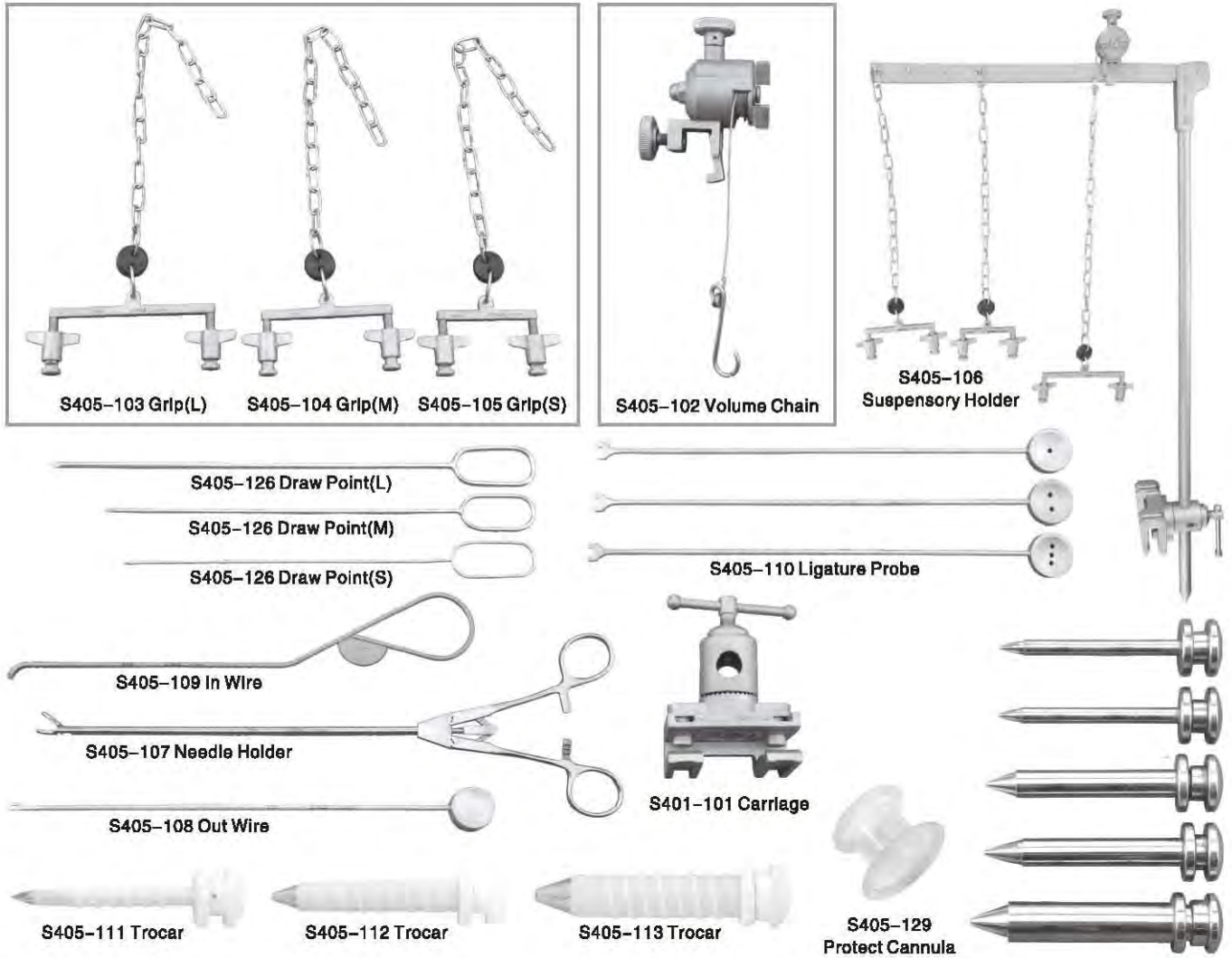



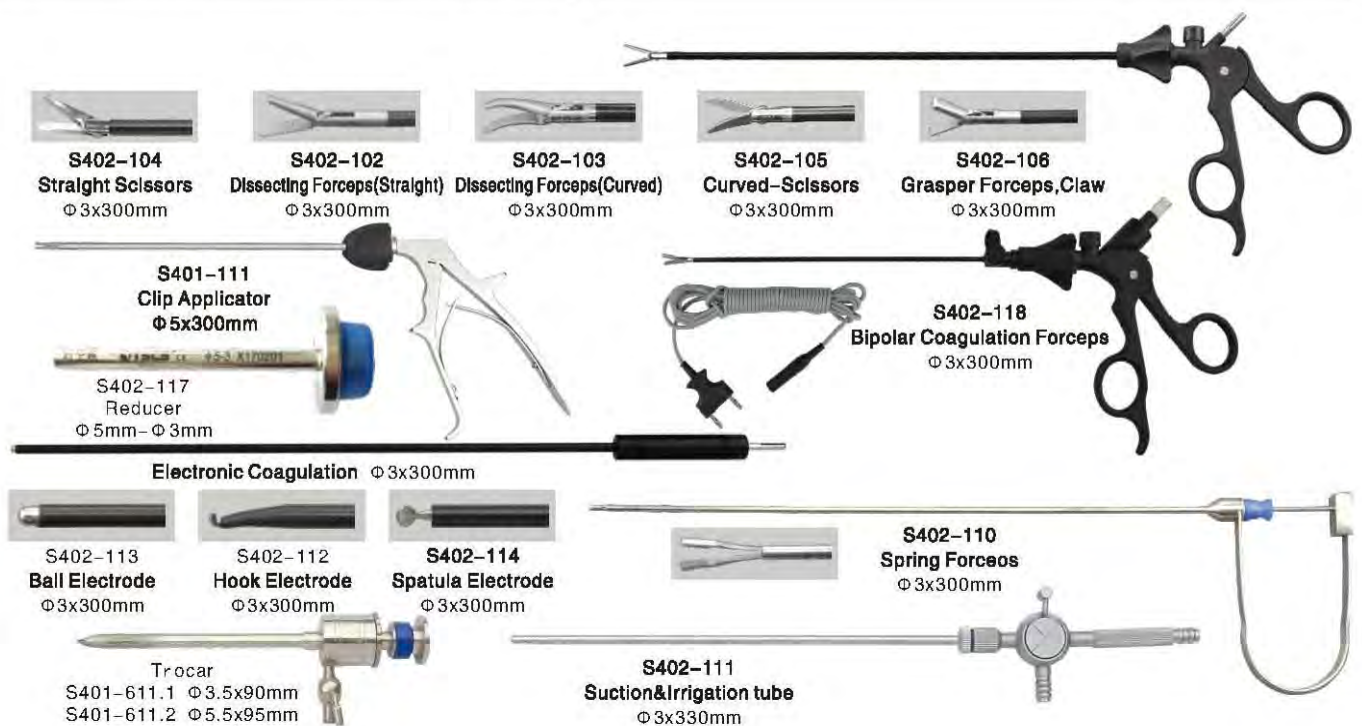

Pediatric Laparoscopy Instrument



Instruments For Thoracoscopic Surgery

Single Port Laparoscopy Instrument



-  **S301-106**
Trocar
Φ12.5mm
-  **S301-107**
Trocar
Φ10.5mm
-  **S301-109**
Trocar
Φ8mm
-  **S301-108**
Trocar
Φ5.5mm

-  **S401-105** Biopsy forceps Φ10x330mm
-  **S401-276-3** Broadness mouth grasper Φ10x330mm
-  **S401-286.3** Needle Φ5x330mm
-  **S301-S-8** Suction & Irrigation Tube Φ5x330mm
-  **S404-103**
Fan-retractor Forceps
Φ10x330mm

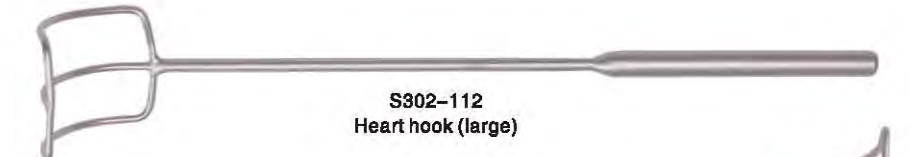
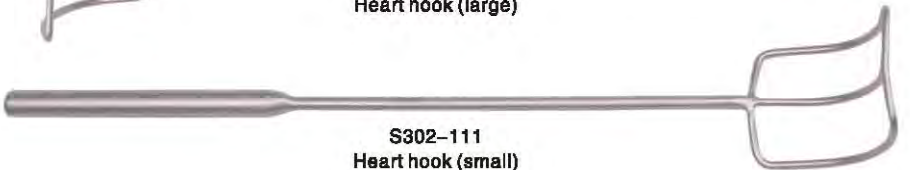
Sternum Retractor

-  **S302-121**
Sternum retractor
-  **S302-112**
Heart hook (large)
-  **S302-111**
Heart hook (small)

Fan-Shaped Forcep

-   **S401-391**
Φ5x330mm
-   **S401-392**
Φ5x330mm
-   **S404-103**
Φ10x330mm



Reusable

Disposable shaft with reusable handle
Perfect compatible
Very economical



S408-256R Scissors, double action	S408-262R Maryland dissector, 30°	S408-264R Maryland dissector, 70°	S408-281R Dorsey grasper	S408-280R Fenestrated grasper
S408-275R Babcock grasper	S408-265R Mixer	S408-271.1R Claw forceps, 2x3 teeth	S408-398R Allis grasper	S408-336R Bowel grasper

Articulating Disposable Instruments



		Rotating Knob Color Indication										
Tips	Code	5mm 350mm										
	S408-256F	Scissors, double action	.									
	S408-262F	Maryland dissector, 30°	.	.								
	S408-264F	Maryland dissector, 70°	.		.							
	S408-281F	Dorsey grasper	.			.						
	S408-280F	Fenestrated grasper	.				.					
	S408-275F	Babcock grasper	.					.				
	S408-265F	Mixer	.						.			
	S408-271.1F	Claw forceps, 2x3 teeth	.							.		
	S408-398F	Allis grasper	.								.	
	S408-336F	Bowel grasper	.									.



Disposable Electrode



φ5x330mm



S408-251.1
Hook



S408-251
Button



S408-251.5
Ball



S408-251.3
Needle



S408-251.2
Knife



S408-251.4
Spatula

Disposable Suction & Irrigation Tube

S408-501-1
With Hook



S408-501-2
Without Hook



Disposable Veress Needle

S408-210 φ2x120mm



S408-212



S408-213



Disposable Retractor Rings



S408-601 Retractor Rings



S408-601-2 Hook, sharp φ5mm



S408-601-3 Hook, blunt φ10mm

Disposable Bipolar Coagulation Forceps



S401-538
Maryland type,
double action



S401-539
Atraumatic,
double action

Thoracoscopy Instrument

Disposable Trocar

TSCS offer you flexibility across surgical specialities, so you can choose the right trocar with the right level of performance when and where it's needed.



Casing in accordance with serrated ergonomic design, both fixation device to prevent slippage, and reduce damage to the skin.

Unique puncture needle design, less trauma, faster healing



Scalable valve with Free reducer.



Blade tips with safety device



S408-207-1
φ 12mm



S408-204-1
φ 10mm



S408-205-1
φ 5mm

Direct visualisation eliminates blind entry by enabling visualisation of tissue layers during insertion and multiple needle tips for choose.



S408-212-2
Visible sleeve φ 12mm

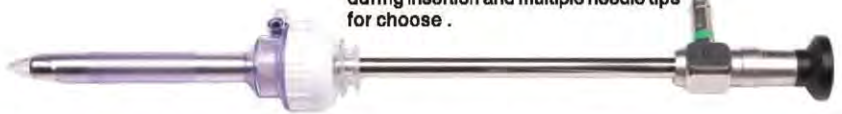

Bladeless Trocar



Safety Trocar



Visible Trocar













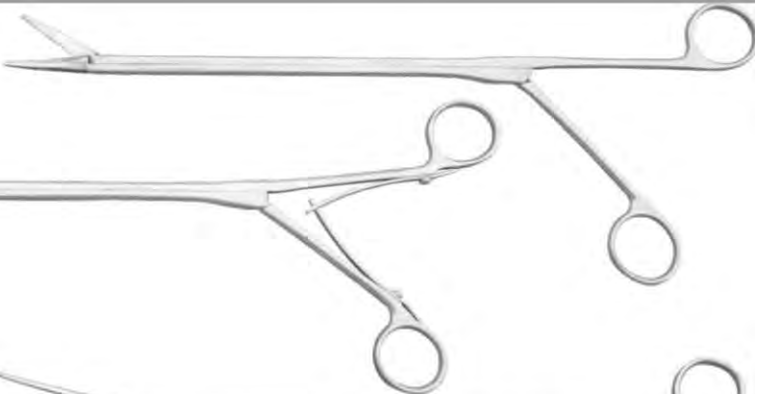



Product Code	Shaft Diameter	Shaft Length	Sleeve
S408-205	φ 5mm	112mm	bladeless
S408-210	φ 10mm	112mm	bladeless
S408-212	φ 12mm	112mm	bladeless

Product Code	Shaft Diameter	Shaft Length	Sleeve
S408-205-1	φ 5mm	112mm	Blade with safety
S408-210-1	φ 10mm	112mm	Blade with safety
S408-212-1	φ 12mm	112mm	Blade with safety







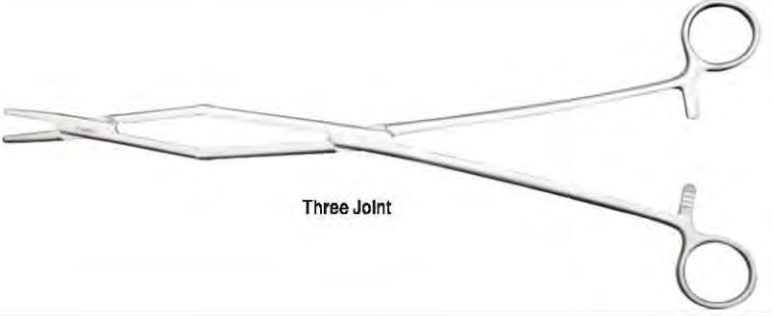

Product Code	Shaft Diameter	Shaft Length	Sleeve
S408-212-2	φ 12mm	112mm	Visible



Instruments for Thoracoscopic Surgery

				
Scissors Curved S301-S-1	Needle Holder S301-S-2			
				
Tissue forceps, oval type (no teeth) S301-S-3 Large S301-S-4 Medium S301-S-5 Small	Dissector Forceps Straight S301-S-6			
				
Lung Forceps S301-S-7 Large S301-S-8 Small	Tissue forceps, oval type (with teeth) S301-S-9 Large S301-S-10 Medium S301-S-11 Small	Dissector Forceps S301-S-12 large curved S301-S-13 small curved	Tissue Forceps S301-S-14	
				
Hamostatic Forceps S301-S-15 (15) S301-S-16 (20) S301-S-17 (25)	Hamostatic Forceps S301-S-18 45° S301-S-19 70° S301-S-20 90°	Lymph Gland Forcep S301-S-21 Large S301-S-22 Small	Banana Forceps S301-S-23	Snake forceps S301-S-25

	
Needle Holder S301-S-24	Three Joint

		
Dissector Forceps, straight S301-D-1	Single Joint	
		
Lung Forceps S301-D-2 Large S301-D-3 Small	Tissue forceps, oval type S301-D-7 (15) S301-D-8 (20) S301-D-9 (25)	Tissue Forceps S301-D-4
		
Hamostatic Forceps S301-D-10 (15) S301-D-11 (20) S301-D-12 (25)	Lymph Gland Forcep S301-D-5 Large S301-D-6 Small	Hamostatic Forceps S301-D-13 45° S301-D-14 70° S301-D-15 90°



Multifunctional Uterus Apparatus



Combined Multifunctional Uterus Apparatus

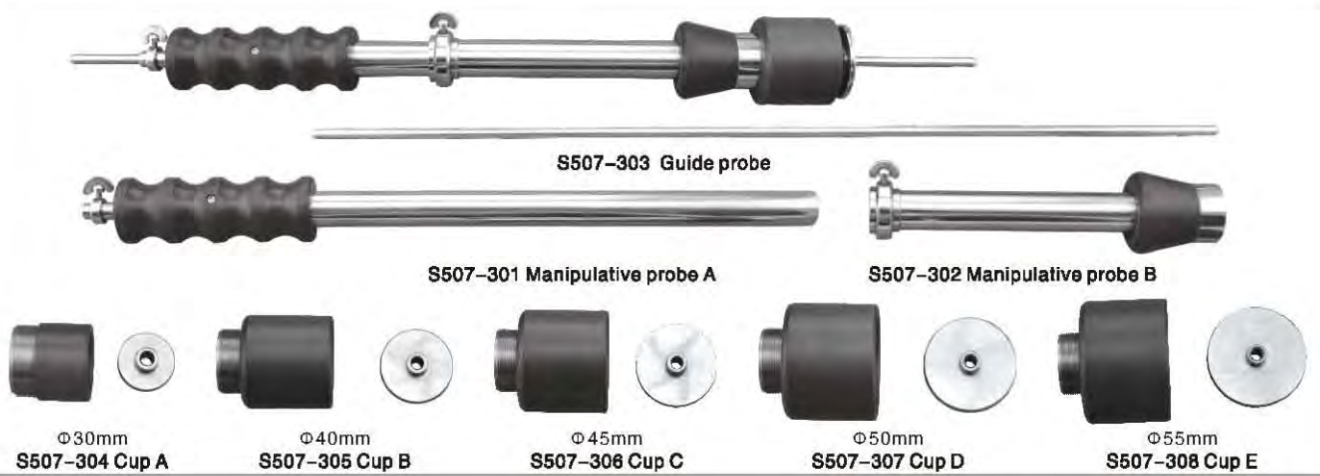

New Uterus Apparatus



Uterus Apparatus





Uterus Apparatus A

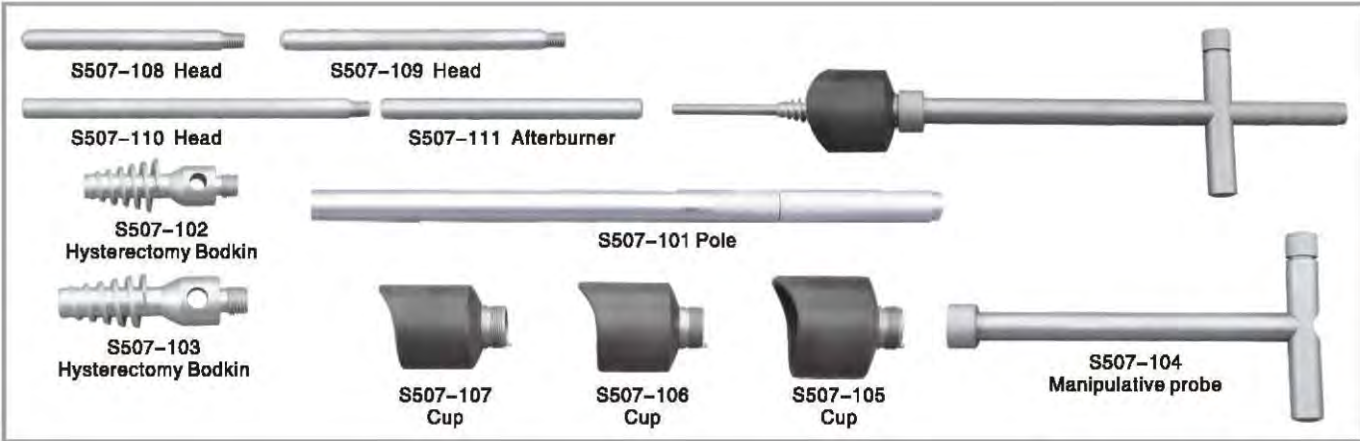

Uterus Apparatus B

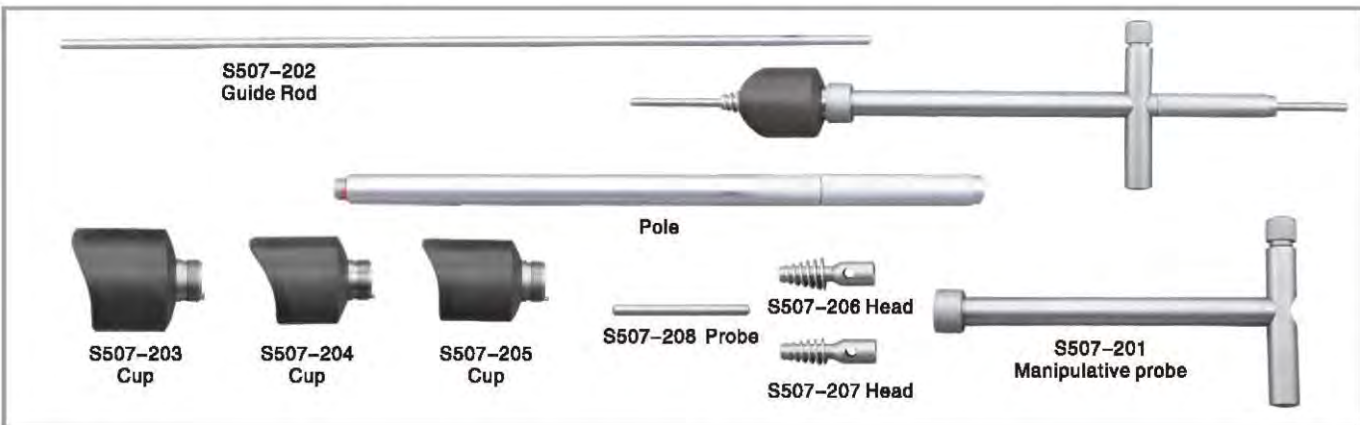

Gynecological Forceps

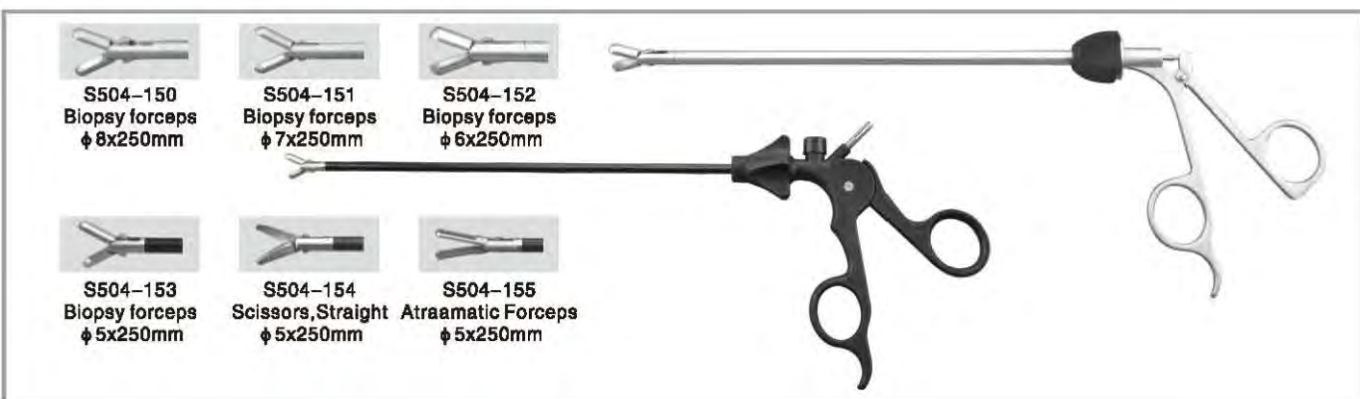

Forceps

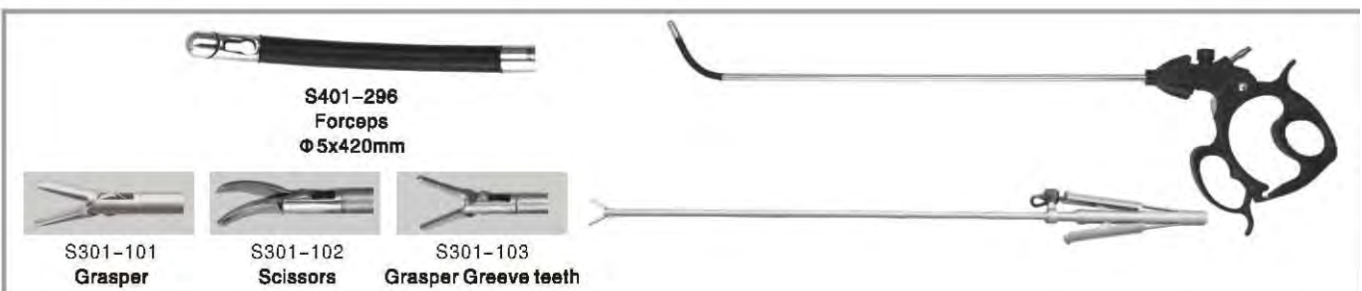



Special Vaginal Retractor (Suture Needle)

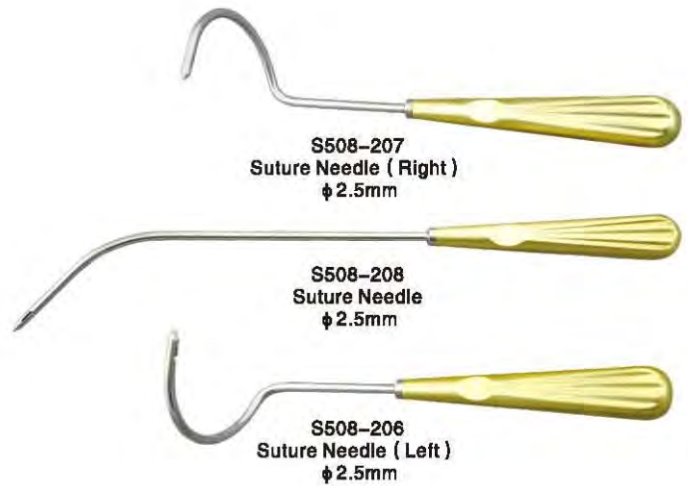
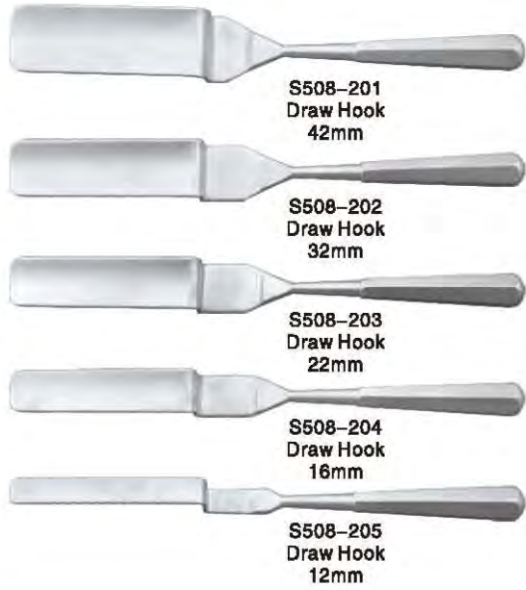

Instruments for Hysterectomy Surgery

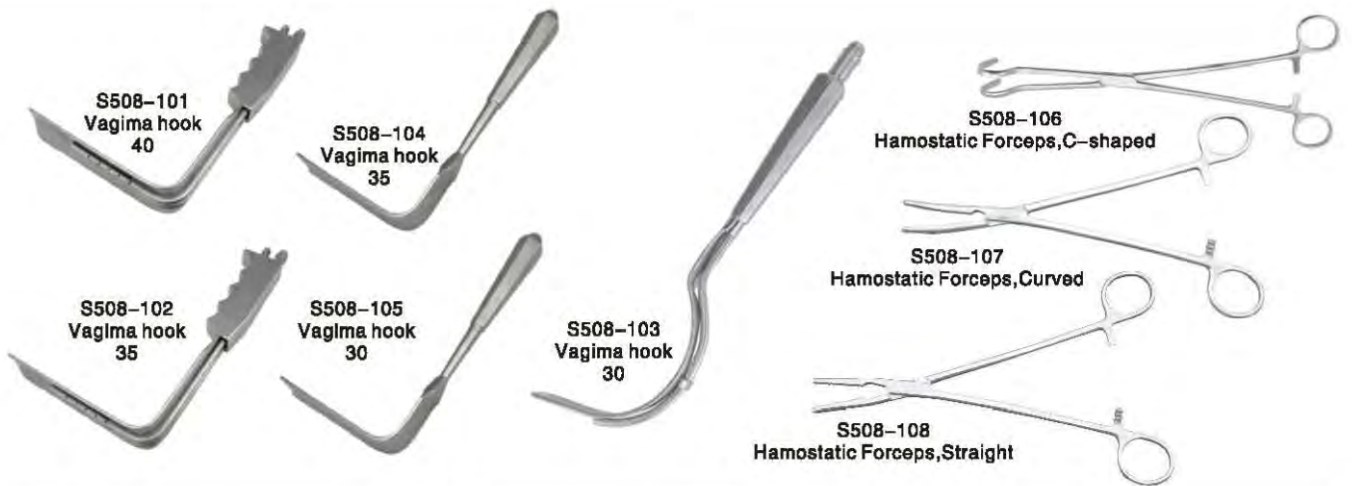

Hysteroscopy (Inspection)

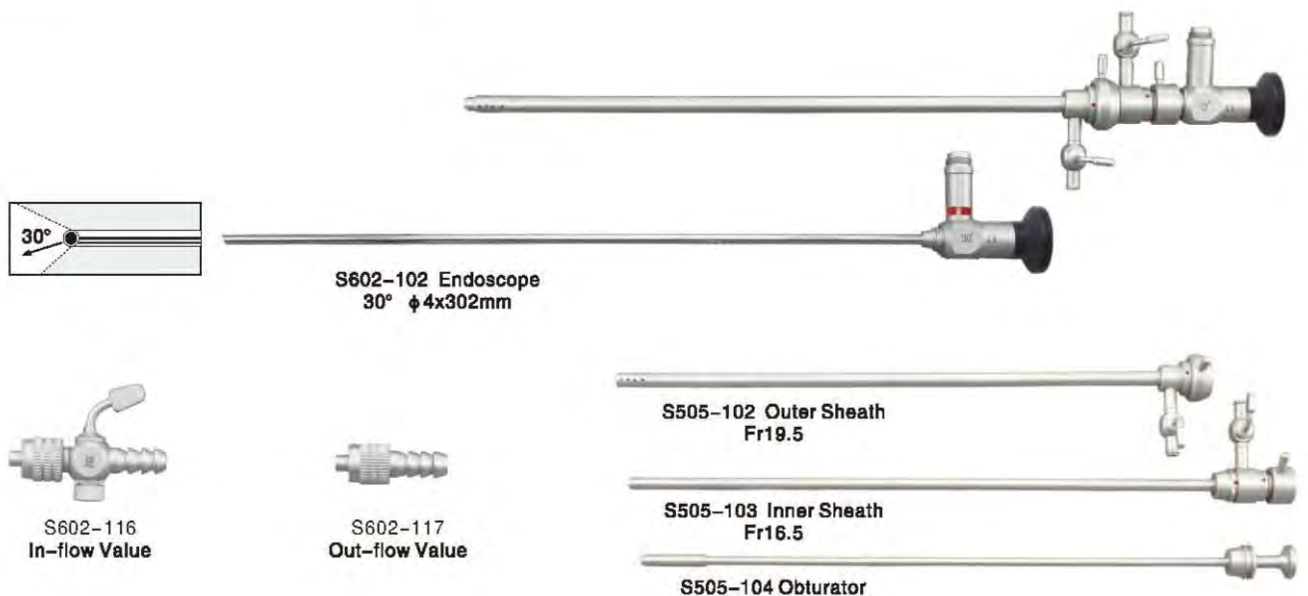



Hysteroscopy

S501-101 Endoscope
22° Ø 6.8x188mm



S501-111 Endoscope 0°
0° Ø 5.6x197mm



S501-102 Brush



S501-103
Scissors Flexible
Ø 2x400mm



S501-104
Biopsy Forceps Flexible
Ø 2x400mm



S501-105
Alligator Grasper flexible
Ø 2x400mm



S501-106
Toothed Forceps Flexible
Ø 2x400mm



S501-107
Ring Forceps Flexible



Hysteroresectoscope



S602-104 Endoscope 4mm, 12°



S502-103 Working Element



S502-117 HF Cable

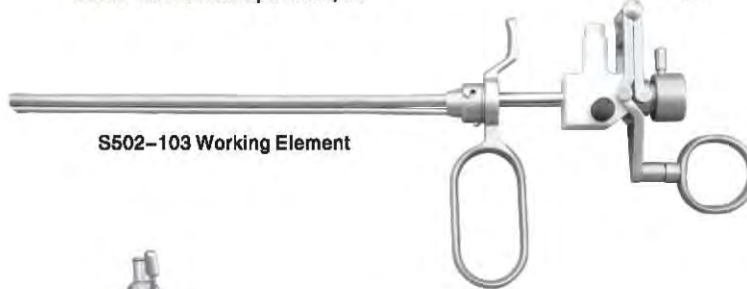

S502-104 Inner Sheath



S502-106 Outer sheath

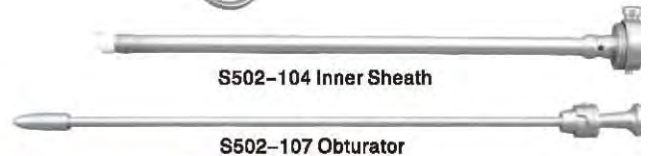

S502-107 Obturator



S502-108 Electrode, Toothed



S502-110 Electrode, Spud



S502-112 Electrode, Ball



S502-109 Electrode, Roller



S502-111 Cutting Loop



S502-113 Electrode, Needle





Hysteroscopy (Work)

Hysteroscopy

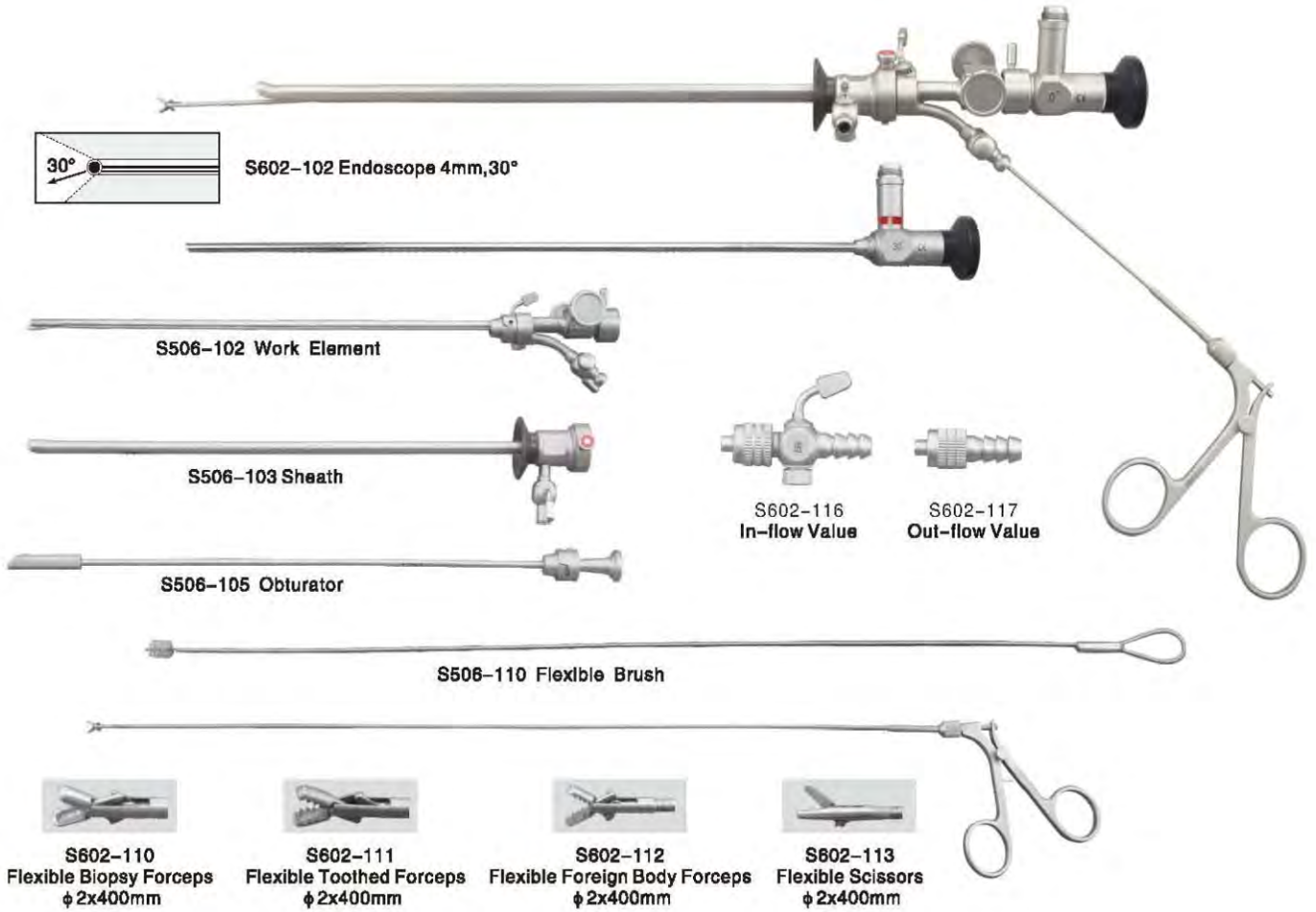

Hysteroscopy

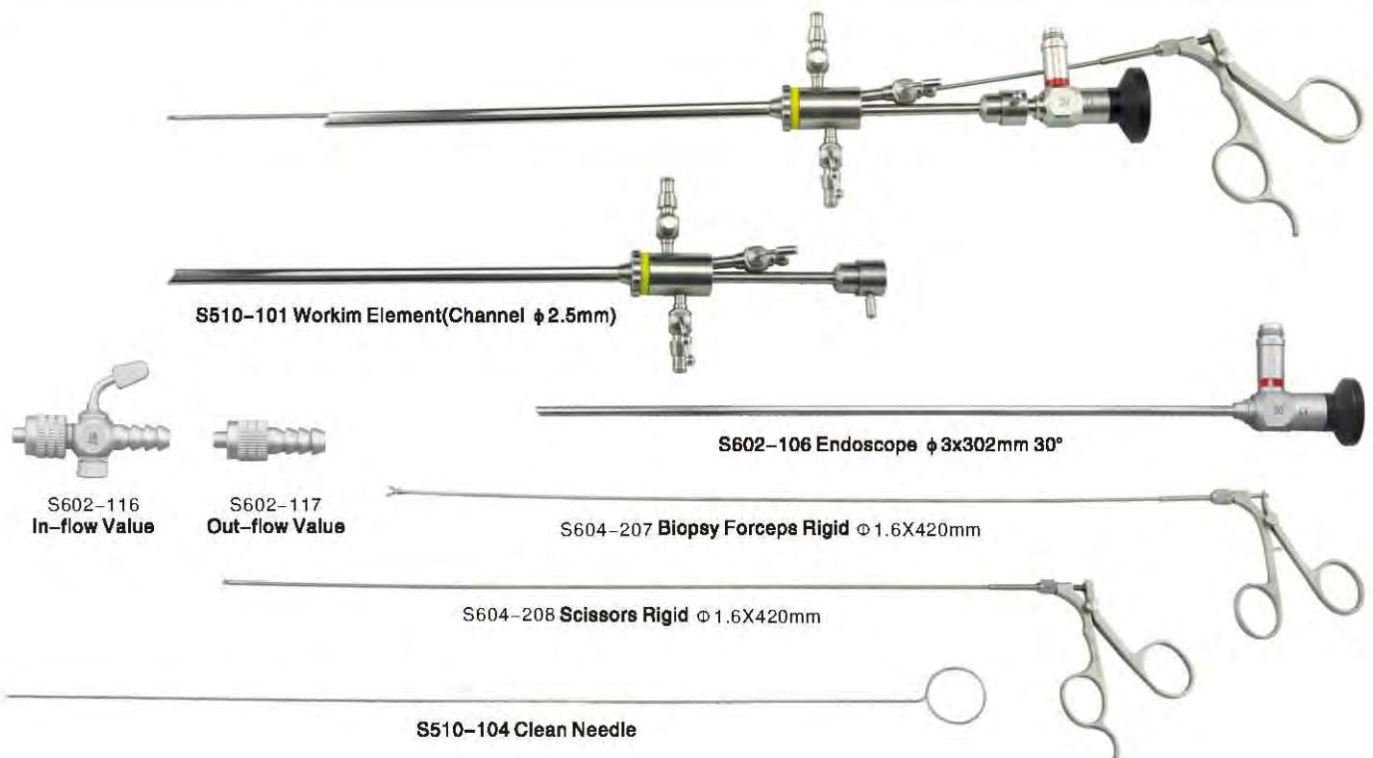



Morcellator



S504-125
Control Unit

Motor Cable



S504-106
Handwheel

S401-258
Scissors
φ5x330mm

S501-109
Uterus Grasping Forceps
φ10x420mm

S504-110
Uterus Grasping Forceps
φ5x420mm



S504-101 Hysterectomia Apparatus φ15x330mm

S504-103 Hysterectomia Apparatus φ18x330mm

S504-102 Hysterectomia Apparatus φ15x330mm

S504-104 Hysterectomia Apparatus φ18x330mm

S504-121 Aiming Stick φ10x500mm

S504-105 Uterus Measuring Stick φ5x500mm

S504-119 Knot-Pushing Stick φ5x420mm

S504-107 Large Bodkin φ10x420mm

S401-461 Push type φ5x330mm

S401-461.1 φ10x330mm

S401-461.2 φ10x330mm

S401-461.3 φ5x330mm



Dilator

- S504-112 φ15-φ10mm
- S504-113 φ18-φ10mm
- S504-113.1 φ15-φ5mm
- S504-113.2 φ18-φ5mm

Reducer

- S504-114 φ18-φ10mm
- S504-115 φ15-φ10mm
- S401-491 φ10-φ5mm
- S504-115.1 φ15-φ5mm
- S504-115.2 φ18-φ5mm

S504-118A
Electric Motor

S504-116 Puncture Cannula φ15x95mm

S504-117 Puncture Cannula φ18x95mm

S504-123 Cervix Forceps

S504-122 Cervix Forceps



Morcellator (Continuous Resection)

Morcellator



S504-125
Control Unit

Motor Cable

S504-101C
Big Uterus Grasping Forceps
φ 10x375mm

S504-102C
Small Uterus Grasping Forceps
φ 5x375mm



S504-105C Converter φ 10-5mm

S504-106C Converter φ 15-10mm

S504-107C Converter φ 18x10mm

S504-108C Hysterectomia Apparatus φ 18x330mm

S504-109C Hysterectomia Apparatus φ 15x330mm

S504-110C Hysterectomia Apparatus φ 10x330mm

S504-121 Aiming Stick φ 10x500mm

S504-114C Knife-Shaped Inner Core φ 10-15mm

S504-115C Knife-Shaped Inner Core φ 10-18mm

S504-122C Dilator
φ 15-10mm

S504-103C Picture Cannula
φ 15x95mm

S504-113C Dilator
φ 10-18mm

S504-104C Picture Cannula
φ 18x95mm

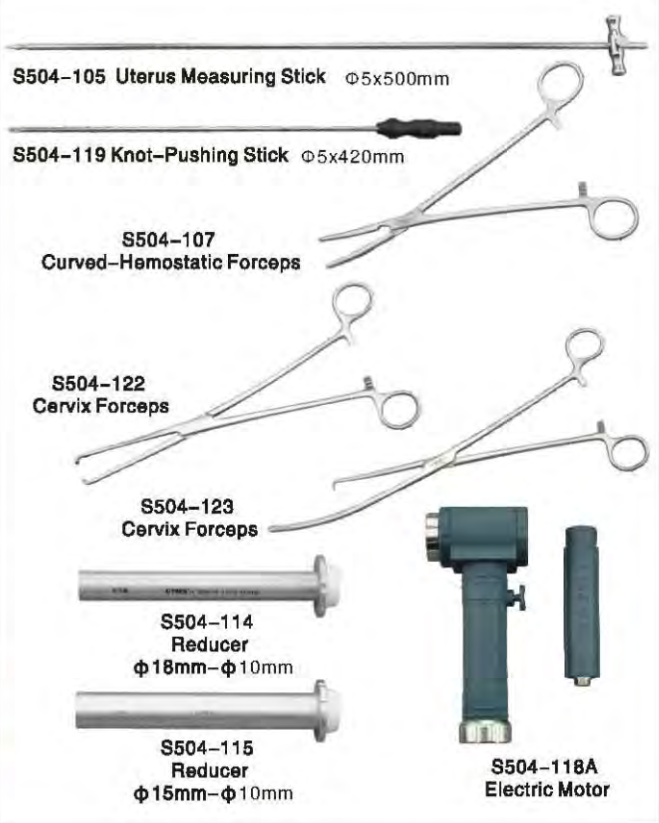

S504-105 Uterus Measuring Stick φ 5x500mm

S504-119 Knot-Pushing Stick φ 5x420mm

S504-107
Curved-Hemostatic Forceps

S504-122
Cervix Forceps

S504-123
Cervix Forceps

S504-114
Reducer
φ 18mm-φ 10mm

S504-115
Reducer
φ 15mm-φ 10mm

S504-118A
Electric Motor



Sinoscope

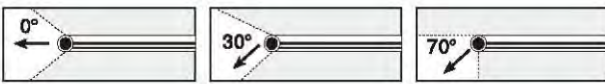

Endoscope ϕ 4x175mm

Nasal tissue forceps, with suction
S205-108 0°

Nasal tissue forceps, with suction
S205-110 45°
S205-112 30°

S205-104
 ϕ 5.2x150mm
Opticla Forceps 0°



S205-105
Scissors, Straight



S205-106
Scissors, Left Curved



S205-107
Scissors, Right Curved



S205-109
Nasal Tissue Forceps 30°



S205-111
Nasal Tissue Forceps 90°



S205-113
Rongeur, front biting



S205-114
Rongeur, back biting



S205-115
Grasper Forceps



S205-116
Polypus Forceps



S205-121
Maxillary Rongeur



S205-117
Sinus Tissue Forceps



S205-122
Trocar
 ϕ 4x90mm



S205-134
Endoscope Holder



S205-119
Sinus Tissue Forceps 70°
 ϕ 3x85mm



S205-132 ϕ 2.5mm Maxillary Suction Tube



S205-133 ϕ 3mm Maxillary Suction Tube

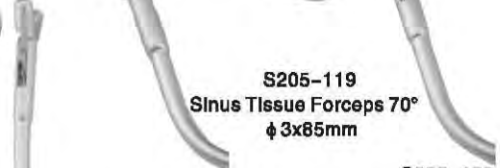

S205-120
Sinus Tissue Forceps 100°
 ϕ 3x85mm

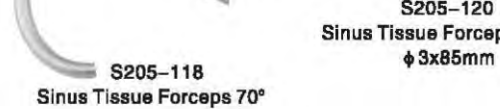

S205-118
Sinus Tissue Forceps 70°



S205-123 Shaped Knife blunt



S205-128 Elevator Double Head

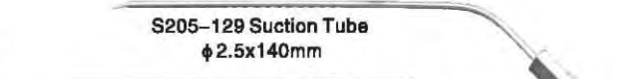

S205-129 Suction Tube
 ϕ 2.5x140mm

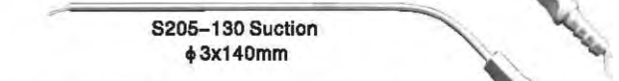

S205-130 Suction
 ϕ 3x140mm



S205-131 Suction
 ϕ 4x140mm



S205-124
Sickle-Shaped Knife Sharp



S205-125
Curette



S205-126
Curette



S205-127
Curette With hole





Pedestal Laryngoscope

ENT

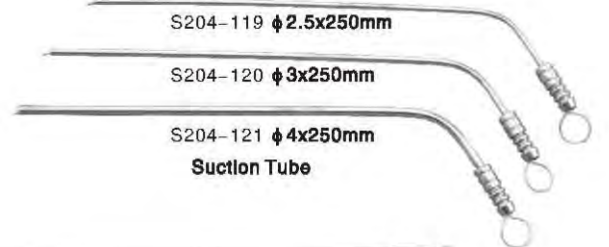
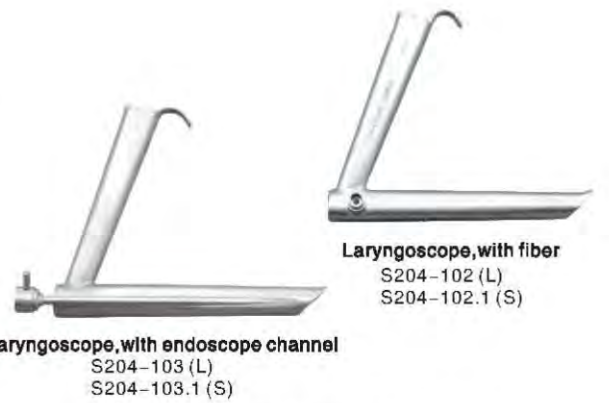
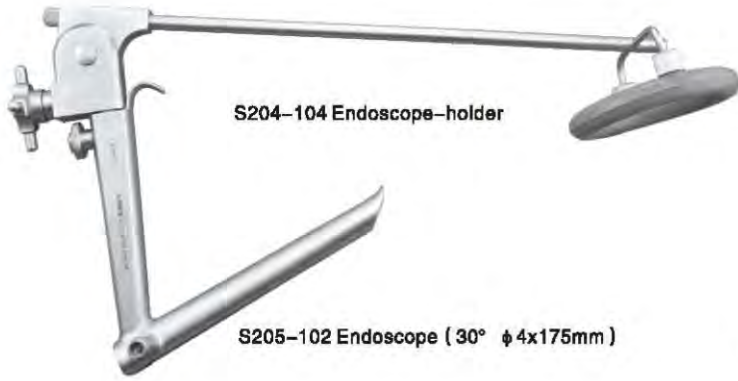

Otoscope Instrument

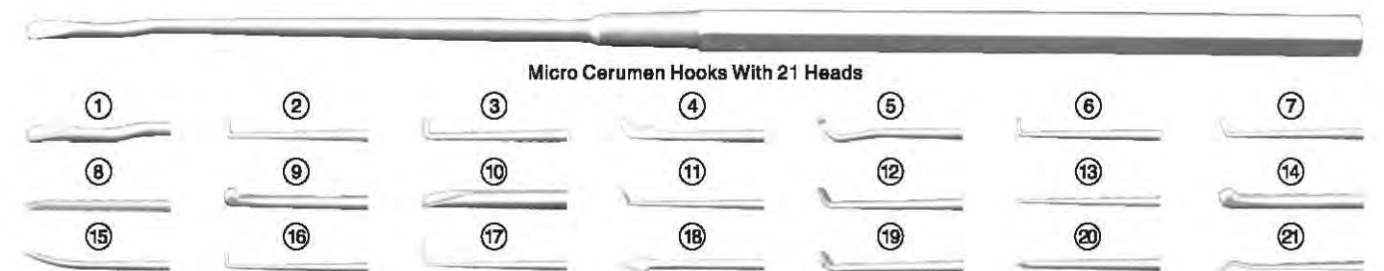
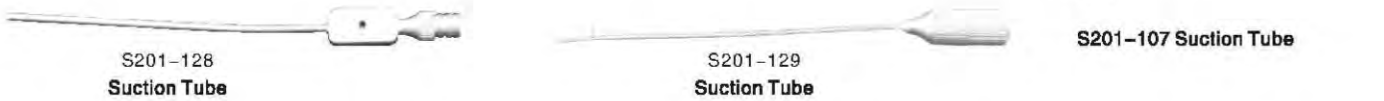
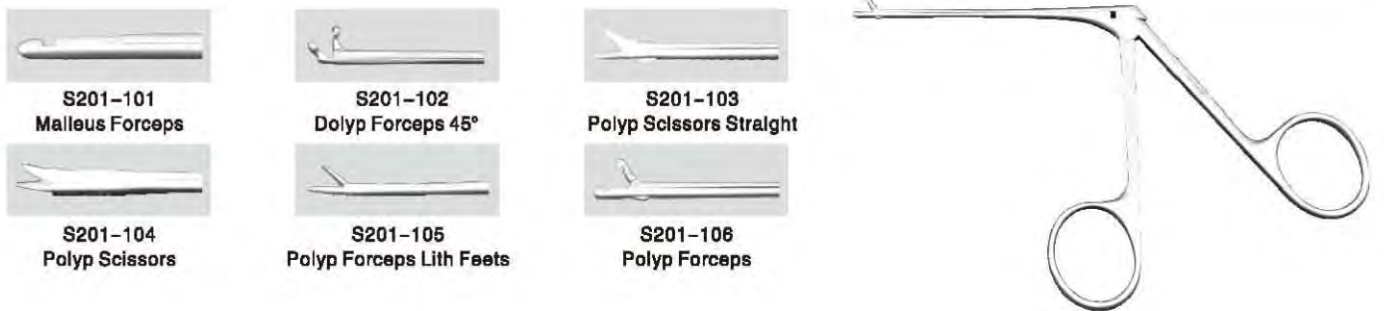



Bronchoscopy

- S207-101 Bronchoscope ϕ 6x280mm
- S207-102 Bronchoscope ϕ 5.5x280mm
- S207-103 Bronchoscope ϕ 5x260mm
- S207-104 Bronchoscope ϕ 4x250mm
- S207-105 Bronchoscope ϕ 3.5x250mm

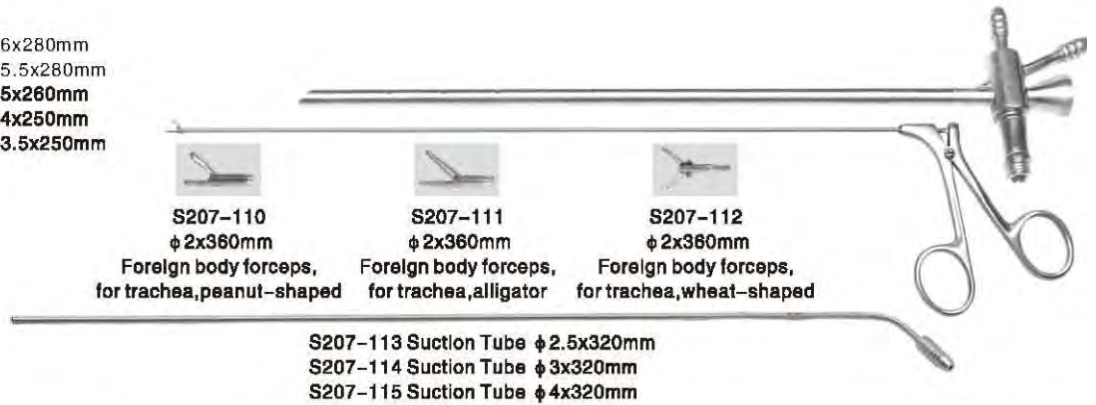

Shaver (for ENT)



Lithotripsy



Lithotripsy

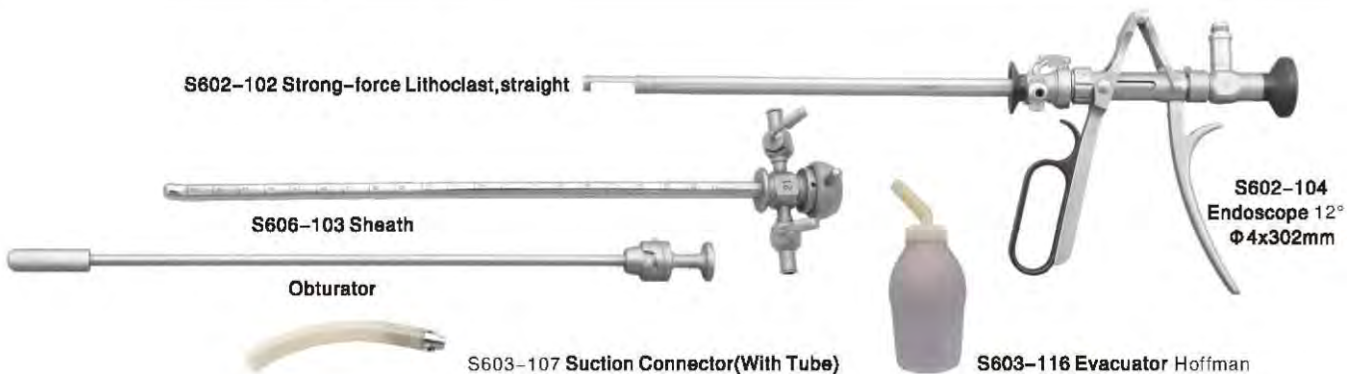

Pelvis Bladder Endoscope

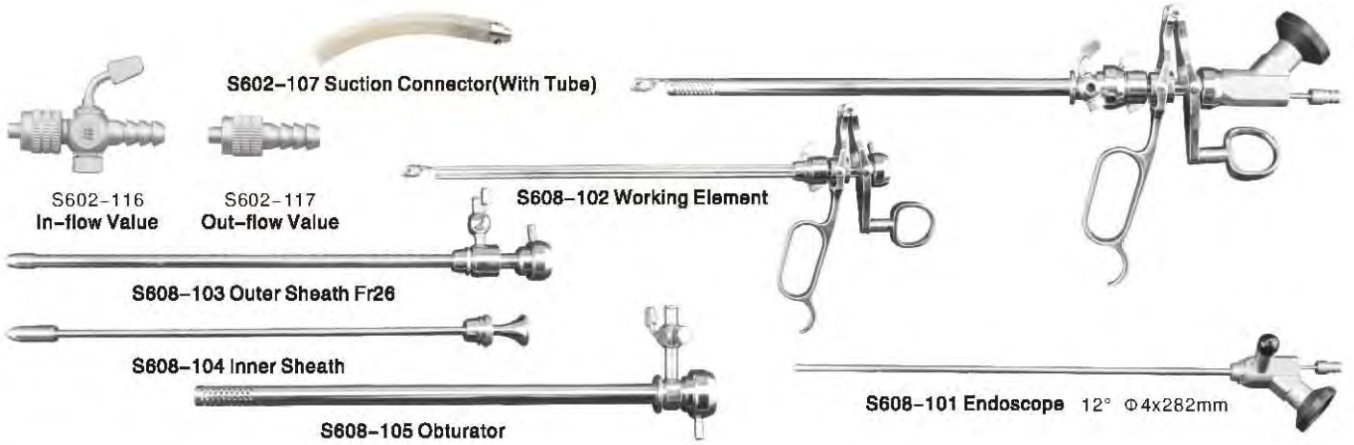

Resectoscopy (worked with Green Laser)

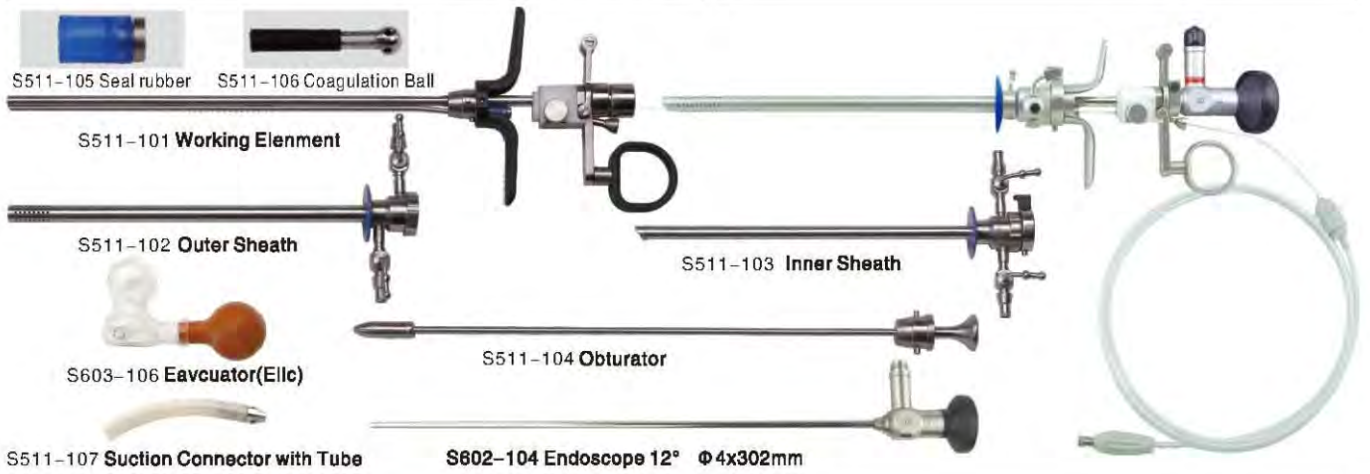

Cystoscope

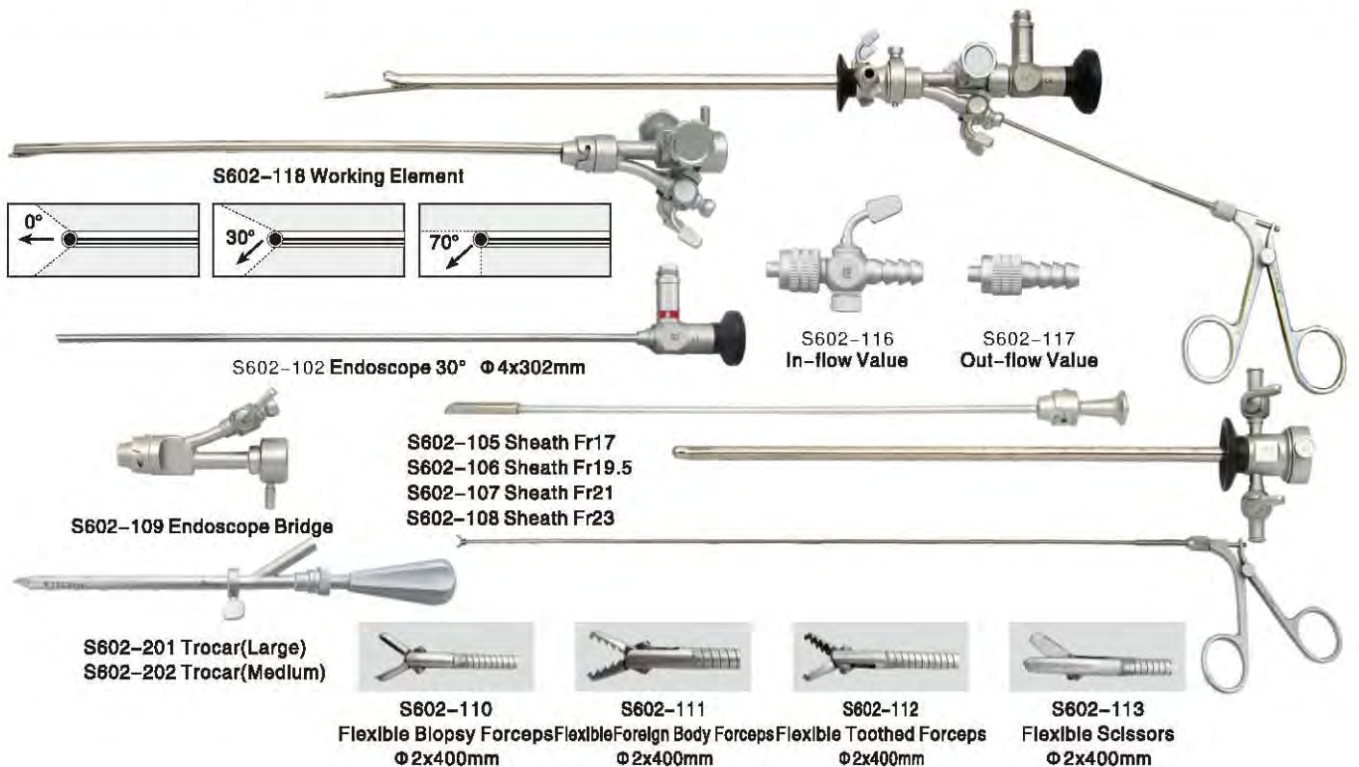



Urethrotomy



Resectoscope

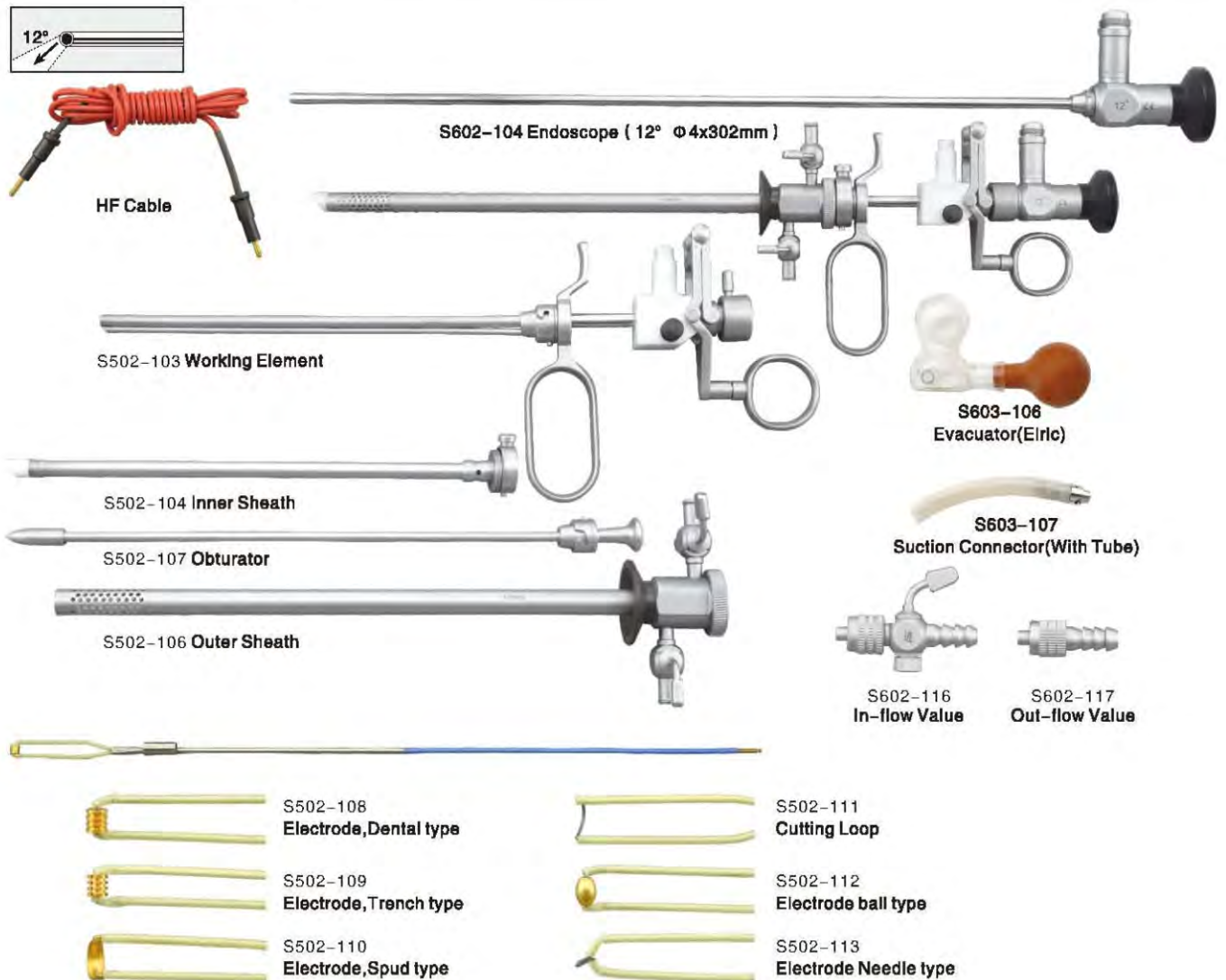

Electrosurgical Unit



S601-102
Electrosurgical Unit

- ★ 400W
- ★ Working Modes and output in every Mode
Cut 5-400W
Falgurate 5-150W
- ★ Bipolar 7-70W
- ★ Voltage:100-220V 50/60Hz
- ★ Used For Laparoscopy any Resectoscopy

Ureterorenoscope



S604-101 Ureterorenoscope Fr7.5

Thyroid Instruments



S402-103 Dissecting Forceps ϕ 3x330mm



S401-611.1 Trocar ϕ 3.5x95mm
S401-611.2 Trocar ϕ 5.5x95mm



Reducer
 ϕ 5-3mm S402-117

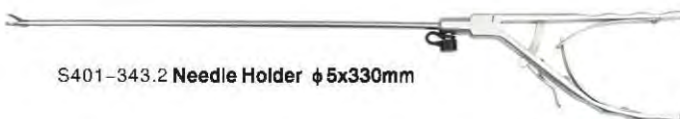

S401-343.2 Needle Holder ϕ 5x330mm



S208-108 Dissecting ϕ 2mm



S208-109 Dissecting ϕ 6mm



S402-111 Suction&irrigation tube ϕ 3x330mm

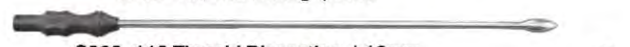

S208-110 Thyroid Dissecting ϕ 10mm

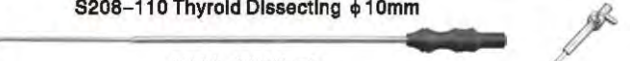

S208-111 Hook

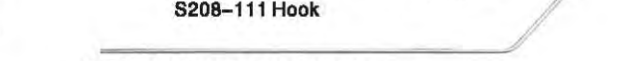

S208-112 Injection Needle ϕ 2.8mm



Arthroscope Instrument



S212-104 Endoscope 0° ,4mm
 S212-105 Endoscope 30° ,4mm
 S212-106 Endoscope 70° ,4mm

S801-104 Sheath, with two stopcocks 0°
 S801-105 Sheath, with two stopcocks 30°
 S801-106 Sheath, with two stopcocks 70°

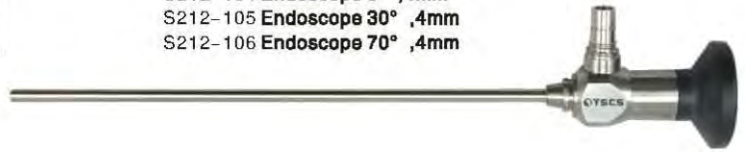

S801-113 Trocar



S801-111 Obturator, blunt
 S801-112 Obturator, sharp

S801-114 Probe



S801-107 0° Puchch forceps, straight
 S801-108 45° Puchch forceps, right curved
 S801-109 45° Puchch forceps, left curved
 S801-115 0° Scissors, straight
 S801-116 45° Scissors, right curved
 S801-117 45° Scissors, Left Curved
 S801-126 Biopsy Forceps
 S801-127 Rongeur
 S801-128 Synovium Forceps

S801-110 Synovium forceps



S801-119 Retrograde Knife
 S801-120 Synovium Knife
 S801-121 Rerrated rosette Knife
 S801-122 Banana Knife
 S801-123 Scacpel
 S801-124 Flat Knife
 S801-125 Curette

Shaver For Arthroscopy



S210-201 Hand Piece

S210-202 Control Unit

S210-203 Foot Switch

S210-204 Blade
 S210-205 Blade
 S210-206 Blade
 S210-207 Blade

Diskoscope



S802-102 Sheath



S802-101
Diskoscope Endoscope 30°
Ø4mm



S802-114
Bayonnetted Forceps
90° 3.2mm



S802-115
Bayonnetted Forceps
90° 4.2mm



S802-116
Bayonnetted Forceps
45°



S802-117
Bayonnetted Forceps
40°



S802-103 Dilator



S802-104 Dissector



S802-105
Short Ball Probe



S802-106
Guide Pen upward length 2.5mm
Guide Pen upward length 3.5mm



S802-107
Long Ball Probe



S802-108
Dissector

Sigmoidoscope



S701-106
Inflating Ball



S602-102
Endoscope 30°



S701-102
Observing Endoscope



S701-103 Operators



S701-104 Obturator



S602-110
Flexible Biopsy Forceps



S602-112
Flexible Foreign Body Forceps



S602-111
Flexible Grasper



S602-113
Flexible Scissors



S701-105 Cotton Forceps



S701-110 Suction



S701-107 Cleaning Brush



Esophagoscope

- S206-101 Esophagoscope ϕ 9x13x180mm
- S206-102 Esophagoscope ϕ 9x10x250mm
- S206-103 Esophagoscope ϕ 11x15x300mm
- S206-104 Esophagoscope ϕ 10x16x350mm
- S206-105 Esophagoscope ϕ 12x18x400mm
- S206-106 Esophagoscope ϕ 12x18x450mm

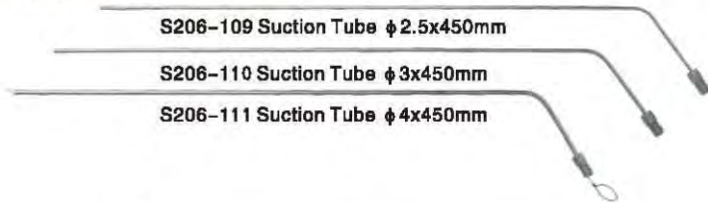

S206-112 Handle



S206-107
 ϕ 4x500mm

Foreign Body Forceps, Duck-Mouth



S206-108
 ϕ 4x500mm

Foreign Body Forceps, Backward teeth



S206-115
 ϕ 4x500mm

Polypus forceps, Brace-shaped



Beauty Surgery Instruments

- S105-008 Mercedes Casing ϕ 5x300mm
- S105-009 Mercedes Casing ϕ 4x300mm
- S105-010 Mercedes Casing ϕ 3x250mm
- S105-011 Mercedes Casing ϕ 3x150mm
- S105-012 Mercedes Casing ϕ 2x150mm
- S105-013 Mercedes Casing ϕ 2x100mm



S105-001 Endoscope Sheath



- S105-002 Mercedes ϕ 5x300mm
- S105-003 Mercedes ϕ 4x300mm
- S105-004 Mercedes ϕ 3x250mm
- S105-005 Mercedes ϕ 3x150mm
- S105-006 Mercedes ϕ 2x150mm
- S105-007 Mercedes ϕ 2x100mm



S105-016 Stripper



S105-014
Stripper Down



S105-015
Stripper Up



S105-016
Stripper Flat



S105-017
Stripper Rhombus



S105-018
Stripper Arc



S105-019
Stripper



S105-020
Stripper



S105-021
Stripper



S105-022
Stripper



S105-023
Stripper



S105-024
Scissors (Straight)



S105-025
Scissors (Curved)



S105-026
Scissors (Hooked)



S105-027
Maryland (Straight)



S105-028
Maryland (Curved)



Otoscope

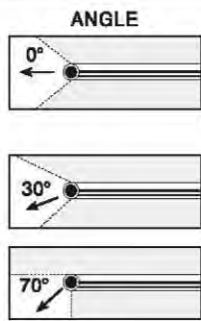

CODE
S216-107
S216-101
 S212-136
 S212-136.1
 S212-136.2
S216-102
S212-137
 S212-137.1

S212-138
 S212-138.1

SPECIFICATION
 Φ 2.7x60mm 0°
 Φ 2.7x95mm 0°
 Φ 4x50mm 0°
 Φ 4x60mm 0°
 Φ 4x95mm 0°
 Φ 2.7x95mm 30°
 Φ 4x50mm 30°
 Φ 4x60mm 30°

 Φ 4x50mm/60mm 70°
 Φ 4x60mm 70°



Otoscope

Sinuscope

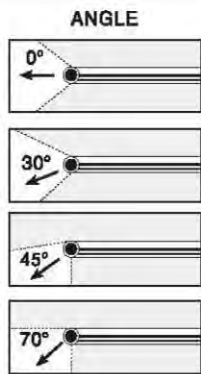

CODE
S212-101
S212-104

S203-102
S205-105

S212-107

S212-106

SPECIFICATION
 Φ 2.7x175mm 0°
 Φ 4x175mm 0° (110° Wide Angle)

 Φ 2.7x175mm 30°
 Φ 4x175mm 30° (110° Wide Angle)

 Φ 4x175mm 45°

 Φ 4x175mm 70°

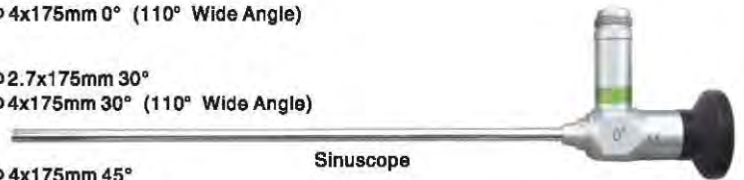

Sinuscope

Laryngoscope

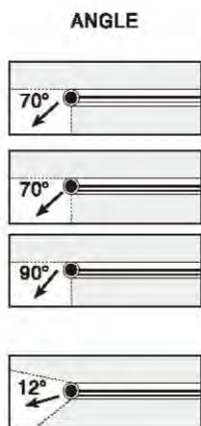

CODE
S212-223

S212-222

S212-221

S212-224

SPECIFICATION
 Φ 5x175mm 70°

 Φ 8x185mm 70°

 Φ 8x185mm 90°

 Φ 4x185mm 12°

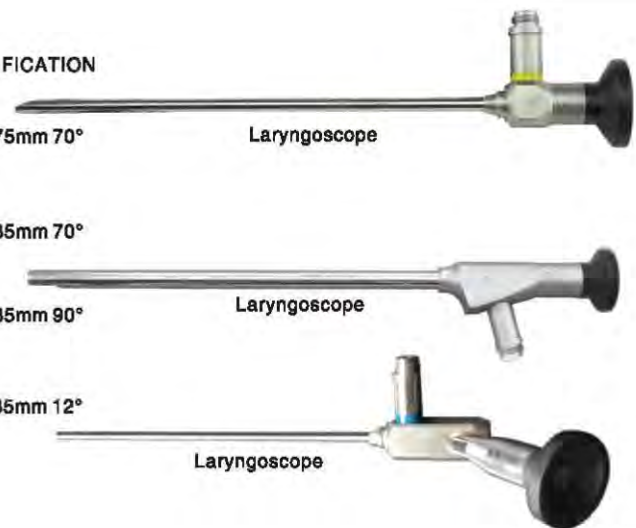

Laryngoscope

Laryngoscope

Laryngoscope

Arthroscope

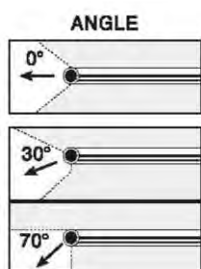

CODE
S212-104

S212-105

S212-106

SPECIFICATION
 Φ 4x175mm 0°

 Φ 4x175mm 30°

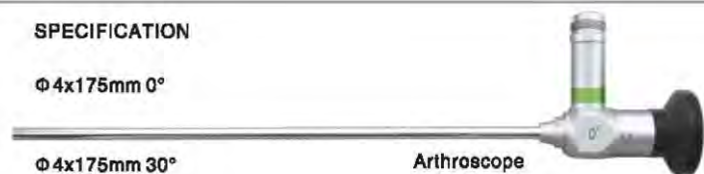

 Φ 4x175mm 70°



Arthroscope



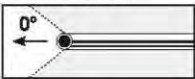
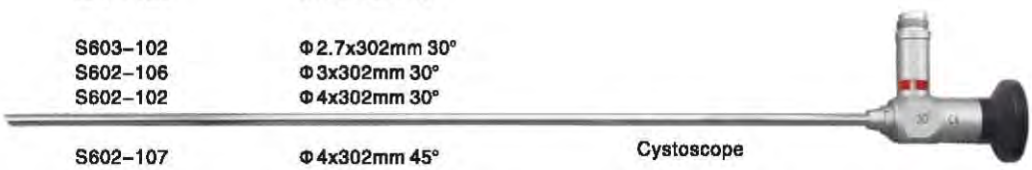
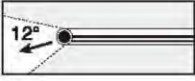
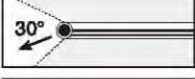
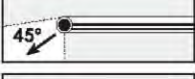



Cystoscope

ANGLE	CODE	SPECIFICATION	
	S603-101 S602-105 S602-101	Φ 2.7x302mm 0° Φ 3x302mm 0° Φ 4x302mm 0°	
	S602-104	Φ 4x302mm 12°	
	S603-102 S602-106 S602-102	Φ 2.7x302mm 30° Φ 3x302mm 30° Φ 4x302mm 30°	
	S602-107	Φ 4x302mm 45°	
	S602-103	Φ 4x302mm 70°	

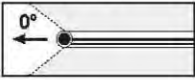
Cystoscope



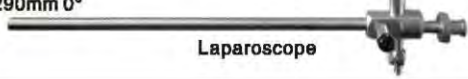



Laparoscope

ANGLE	CODE	SPECIFICATION	
	S401-011 S401-001	Φ 5x305mm 0° Φ 10x330mm 0° (110° Wide Angle)	
	S401-012 S401-002	Φ 5x305mm 30° Φ 10x330mm 30° (110° Wide Angle)	
	S401-003	Φ 10x290mm 0°	

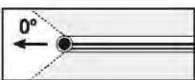
Laparoscope

Laparoscope

Hysteroscope

ANGLE	CODE	SPECIFICATION	
	S501-100 S501-111	Φ 5.6x200mm 0° Φ 6.5x197mm 0°	
	S501-099 S501-101	Φ 5.6x182mm 22° Φ 6.8x188mm 22°	
	S501-103	Φ 6.5x195mm 30°	
	S602-102	Φ 4x302mm 30°	

Hysteroscope

Hysteroscope



V230-HD-1

- HD V230-HD Waterproof camera**
- ▶ Resolution:1920x1080
 - ▶ Display:9 Inch LCD screen
 - ▶ TV System:PAL&NTSC
 - ▶ SNR:54db
 - ▶ Video output:S-video,RGB,HDMI
 - ▶ White Balance:AWC,Manu,Auto Function:Auto Freeze,Zoom,record



S904-103

- LED light source**
- ▶ 100W LED
 - ▶ Direct current fan Quiet operation
 - ▶ Lamp life ≥ 50,000 hour
 - ▶ Low temperature no infrared and ultraviolet rays
 - ▶ 6500k color temp. approx. = Natural sunlight
 - ▶ No high voltage components very Safe and efficient environment



S904-106.1

- Suction irrigation pump**
- ▶ Fully automatic, easy intuitive pressure suction and irrigation can be adjusted according to surgery setting
 - ▶ Maximum liquid volume ≥ 5000ml/min
 - ▶ Low noise with superior performance, special filters ensure optimally sterile conditions for minimally invasive surgery
 - ▶ Range of pos-pressure:10-50kPa
 - ▶ Range of neg-pressure:-50-10kPa



S904-104

- Inflator**
- ▶ Fully automatic, quiet operation
 - ▶ range of fw.:10-30L,3 level flow rate
 - ▶ Automatic safety alarm function
 - ▶ Gas supply design for great safety
 - ▶ Dual gas filtering and decompression design
 - ▶ Range of press:5-30mmHg





S904-108

- Auto pump**
- ▶ used for Arthroscopy, Hysteroscopy and Urology systems
 - ▶ Sterile tubing sets with sensor, a peristaltic pump, with two channels
 - ▶ Emulsion tube and shim are replaceable (5pcs, L: approx.16cm)
 - ▶ High sensitivity pressure sensor
 - ▶ Range of press:10-400mmHg(2-53.3kPa)
 - ▶ Range of fw.:0.1-1.0 L/min



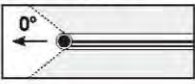
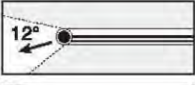
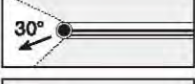
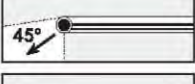

Cystoscope

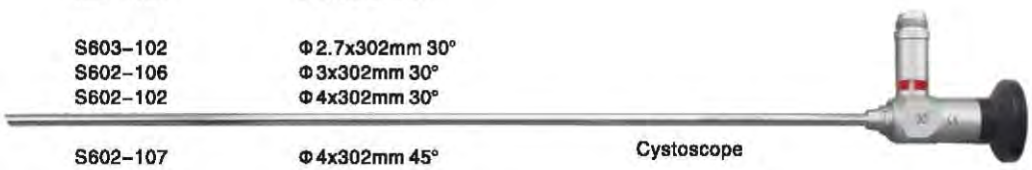
ANGLE	CODE	SPECIFICATION
	S603-101 S602-105 S602-101	Φ 2.7x302mm 0° Φ 3x302mm 0° Φ 4x302mm 0°
	S602-104	Φ 4x302mm 12°
	S603-102 S602-106 S602-102	Φ 2.7x302mm 30° Φ 3x302mm 30° Φ 4x302mm 30°
	S602-107	Φ 4x302mm 45°
	S602-103	Φ 4x302mm 70°

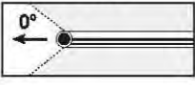

Cystoscope

Laparoscope

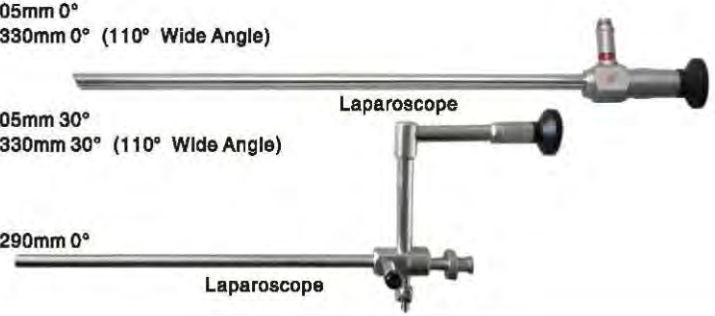

ANGLE	CODE	SPECIFICATION
	S401-011 S401-001	Φ 5x305mm 0° Φ 10x330mm 0° (110° Wide Angle)
	S401-012 S401-002	Φ 5x305mm 30° Φ 10x330mm 30° (110° Wide Angle)
	S401-003	Φ 10x290mm 0°



Laparoscope

Laparoscope

Hysteroscope

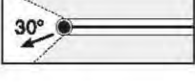
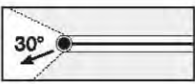
ANGLE	CODE	SPECIFICATION
	S501-100 S501-111	Φ 5.6x200mm 0° Φ 6.5x197mm 0°
	S501-099 S501-101	Φ 5.6x182mm 22° Φ 6.8x188mm 22°
	S501-103	Φ 6.5x195mm 30°
	S602-102	Φ 4x302mm 30°



Hysteroscope



Hysteroscope



Hysteroscope



Hysteroscope



TriMed Technologies

Customise Surgical Solution & Instruments

4/E-1, Second Floor, Nuchana Tower,
Alaknanda Shopping Complex, Alaknanda, New Delhi - 110019 (INDIA)

Ph:- +91-11-41051188, Mobile:-+91-8459130431

Email: trimedtechnologies@gmail.com, info@tri-med.in

Web: www.trimed.co.in