



TriMed

**EAR, NOSE & THROAT
SURGICAL CATALOGUE**



ENT



**ISO & CE Certification
For More Reliability...**



Quality Policy

"We are committed to provide a better quality product which suits the customer requirements & keep on improving resource utilization to best of our efforts"



TriMed

ABOUT US

TriMed Technologies was established with a mission to provide our valued clients with impeccable service in the field of advance and update, finest quality hand crafted **E.N.T. SURGICAL INSTRUMENTS**. Along with our team of professionals, we always strive for a "TOTAL QUALITY SERVICE", applied at every stage of manufacturing process which are totally in-house controlled. This resulted in a constant up gradation of the product and consequently, diversification in its range. Moreover, we maintain a good rapport and confidence with leading surgeons / hospitals in India and Asia. Now, we desire to establish and acquire similar confidence / trust from you by fulfilling your requirements of E.N.T. SURGICAL INSTRUMENTS made of STAINLESS STEEL and TITANIUM. We once again ensuring you personalize, efficient, time bound service which is our objective that we at TRIMED strive for.

E

N

T



INSTRUMENTS CARE

Since the E.N.T. surgical instruments are precision in nature, you are requested to follow the undermentioned instructions for maintaining its delicate and finish properties.

CLEANING

Distilled or mineral water should be used to decontaminate & rinsed the instruments. For removal of contaminated stuck on the surface use soft bristled brush or ultrasonic cleaner.

STERILIZATION

Use distilled water in autoclave.

Autoclave should be rust proof from inside otherwise rust may transfer by steam. During dry heat sterilization the temperature should be fully controlled otherwise instrument's hardness may get effected.

STORAGE

Instruments should be fully dried by hair dryer or in oven with temperature at 70°C - 80°C. Medical grade oil can be used on serration, joints, locks, hinges & knurled parts of the instruments.

The company reserve the right to change the shapes/specifications of the instruments without prior notice.

E

N

T

E

N

T



CONTENTS

OTOLOGY	01-14
RHINOLOGY / RHINOPLASTY.....	15-23
SINUSCOPY	24-29
TONSILLECTOMY	30-33
LARYNGOLOGY	34-39
GENERAL INSTRUMENTS & EQUIPMENTS.....	40-48
INSTRUMENTS SET.....	49-61
BLACK FINISH INSTRUMENTS	62



OTOLOGY



-  4.5mm Ø
-  5.5mm Ø
-  6.5mm Ø
-  7.5mm Ø

GRUBER Aural Specula
Set of 4
03



-  4.5mm Ø
-  5.5mm Ø
-  6.5mm Ø
-  7.5mm Ø

HARTMAN Aural Specula
Set of 4 - Black finish
4.5mm, 5.5mm, 6.5mm, 7.5mm
06



ROSEN
Aural Slotted Specula
Set of 4 - Black finish
09



ROSEN
Aural Specula
Set of 4 - Black finish
12



TUMARKIN TAPERED SLOTTED
Aural Specula
Set of 4 - Black finish
15



SHEA
Aural Specula
Set of 4 - Black finish
18



HOLMGREN
Aural Specula
Self Retaining - Black finish



AURAL Syringe
all metal
4 OZ with 2 Pipe



SIEGLE
Pneumatic Speculum
Set of 4 in wooden box



GARDINER
TuningFork128-256-
512-1024-2048-4096
30



HARTMANN
TuningFork128-256-
512-1024-2048-4096
33



EUSTACHIAN
CATHETERS
36



JOBSON
HORNPROBE
39



BuckCurette
42



FORMBY Cereman
Scoop&Hook
42



ForeignBody&
HardWaxRemoving
45



ForeignBody
Removing
48



EarVectis
withscoop
51



HOVELL
Loop
54



OTOLOGY



WILDE
AuralForcep
57Small
60Large



FAGGE
AuralBayonet
Forcep
63 Serrated
63 1x2teeth



ADSON
PlainForcep
66
66



ADSONForcep
with1x2teeth
69
69

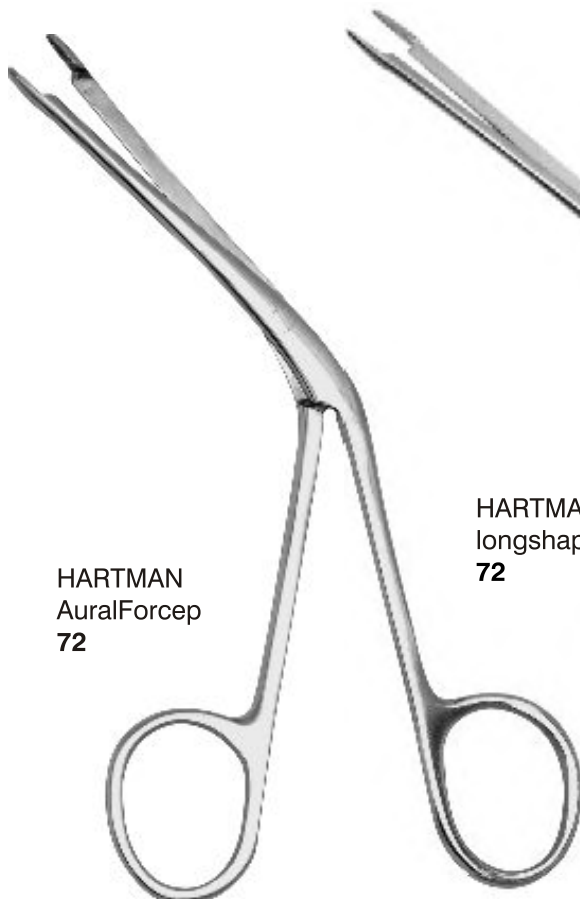

HARTMAN
AuralForcep
72



HARTMANAural Forceps
longshape15cm
72



OSSICLE
HoldingForcep
75



TILLEY
Aural Forceps
7



LEMPERT
Endural Speculum
Right/Left



LEMPERT
Rongeur
4 Straight
7 Curved



LEMPERT
Rongeur Double
Action Curved



PLESTER
Self Retaining Retractor
2x2 Prongs
3



PLESTER
Self Retaining Retractor
2x3 Prongs
3



WULLSTEIN
Self Retaining Retractor
3x3 Prongs
6



WULLSTEIN
SelfRetainingRetractor
99 4x4prongs
1023x4prongs



JANSEN
Retractor
105



PLESTERJANSEN
RetractorSolidBladeLeft
108



PLESTERJANSEN
RetractorSolidBladeRight
111



GLEGG
AuralSnare
114



JANSENChisel
2mmtto10mm
Length140mm
117



JANSENOSTEOTOME
2mm,3mm,4mm,
6mm,8mm,10mm
Length140mm
120



JENKINS GOUGE
2-10mm Length 140mm
123



CONE Self Retaining Adjustable Retractor
126



LEMPERT ENDURAL Retractor
126



LEMPERT Mastoid Curette
1mm-5mm (5 sizes)
129



FARABEUF Elevator Curved
132



KERRISON Punch
Upward & downward Cutting
size-1mm, 2mm, 3mm, 4mm
135



Lake Seeker
138



HOUSES Graft Press Forceps
141 - Round shape
141 - Square shape



OTOLOGY

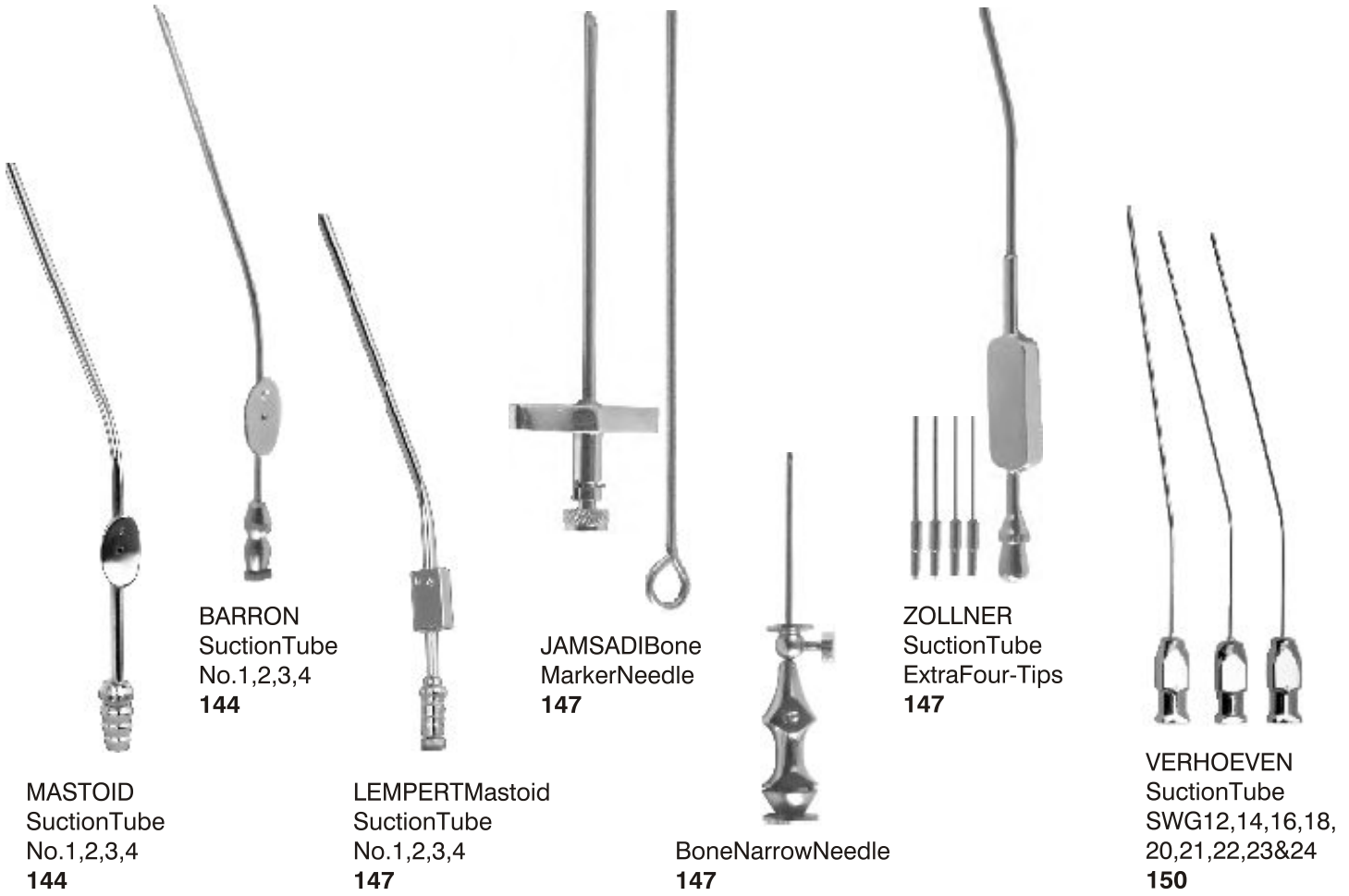

BARRON
Suction Tube
No.1,2,3,4
144

JAMSADIBone
Marker Needle
147

ZOLLNER
Suction Tube
Extra Four-Tips
147

VERHOEVEN
Suction Tube
SWG12,14,16,18,
20,21,22,23&24
150

MASTOID
Suction Tube
No.1,2,3,4
144

LEMPERTMastoid
Suction Tube
No.1,2,3,4
147

BoneNarrow
Needle
147



VERHOEVEN
Suction Tube Holder
153



156



159



162



165

MicroAural Forceps Serrated
S. Steel & Black finish
156 Microstraight
156 Upward
159 Micro1x2teeth
162 Right Curved
165 Left Curved

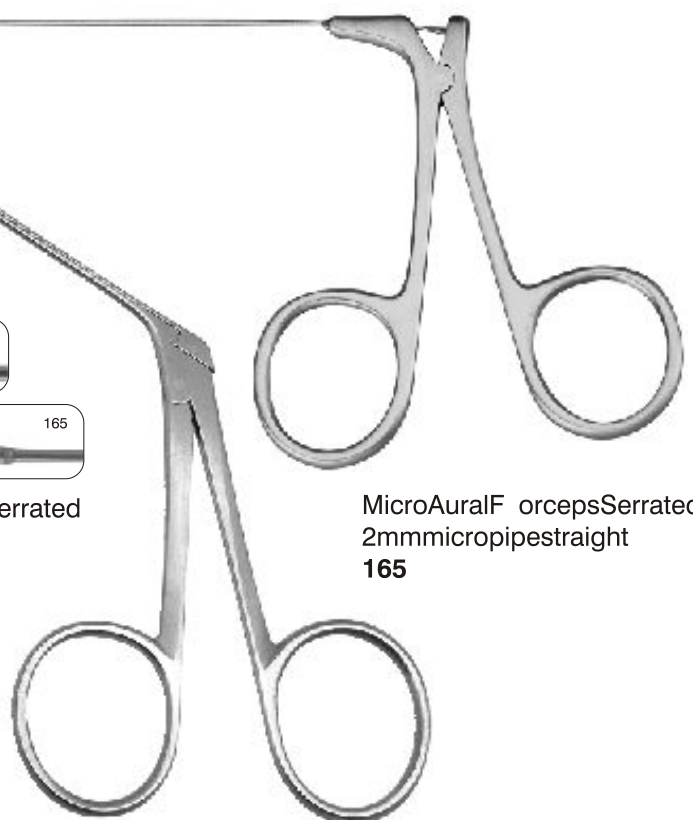

MicroAural Forceps Serrated
2mm micro pipe straight
165



Temporal Bone Holder
153

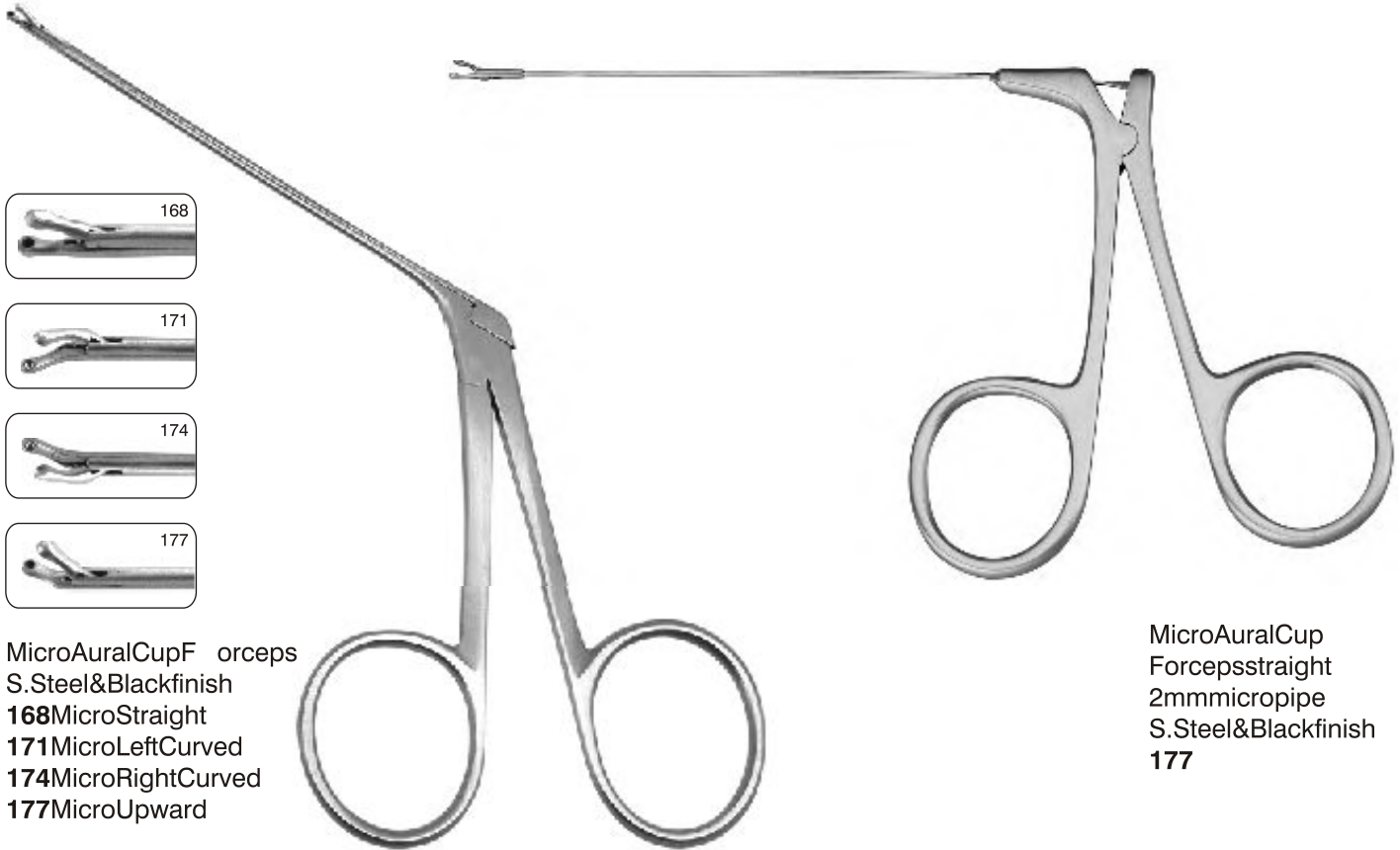

MicroAuralCup Forceps
S.Steel&Blackfinish
168MicroStraight
171MicroLeftCurved
174MicroRightCurved
177MicroUpward

MicroAuralCup
Forcepsstraight
2mmmicropipe
S.Steel&Blackfinish
177

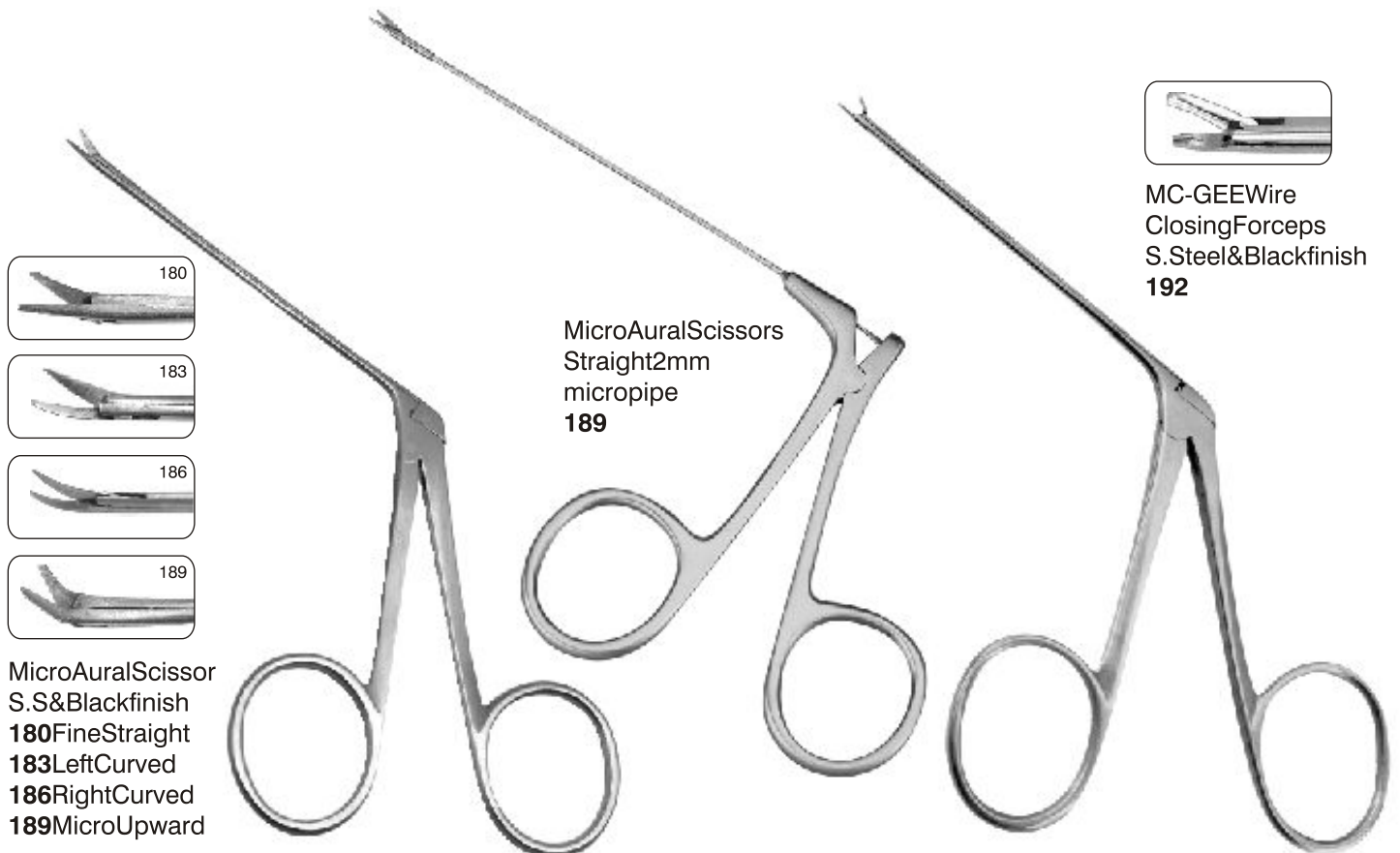

MicroAuralScissor
S.S&Blackfinish
180FineStraight
183LeftCurved
186RightCurved
189MicroUpward

MicroAuralScissors
Straight2mm
micropipe
189

MC-GEEWire
ClosingForceps
S.Steel&Blackfinish
192



OTOLOGY

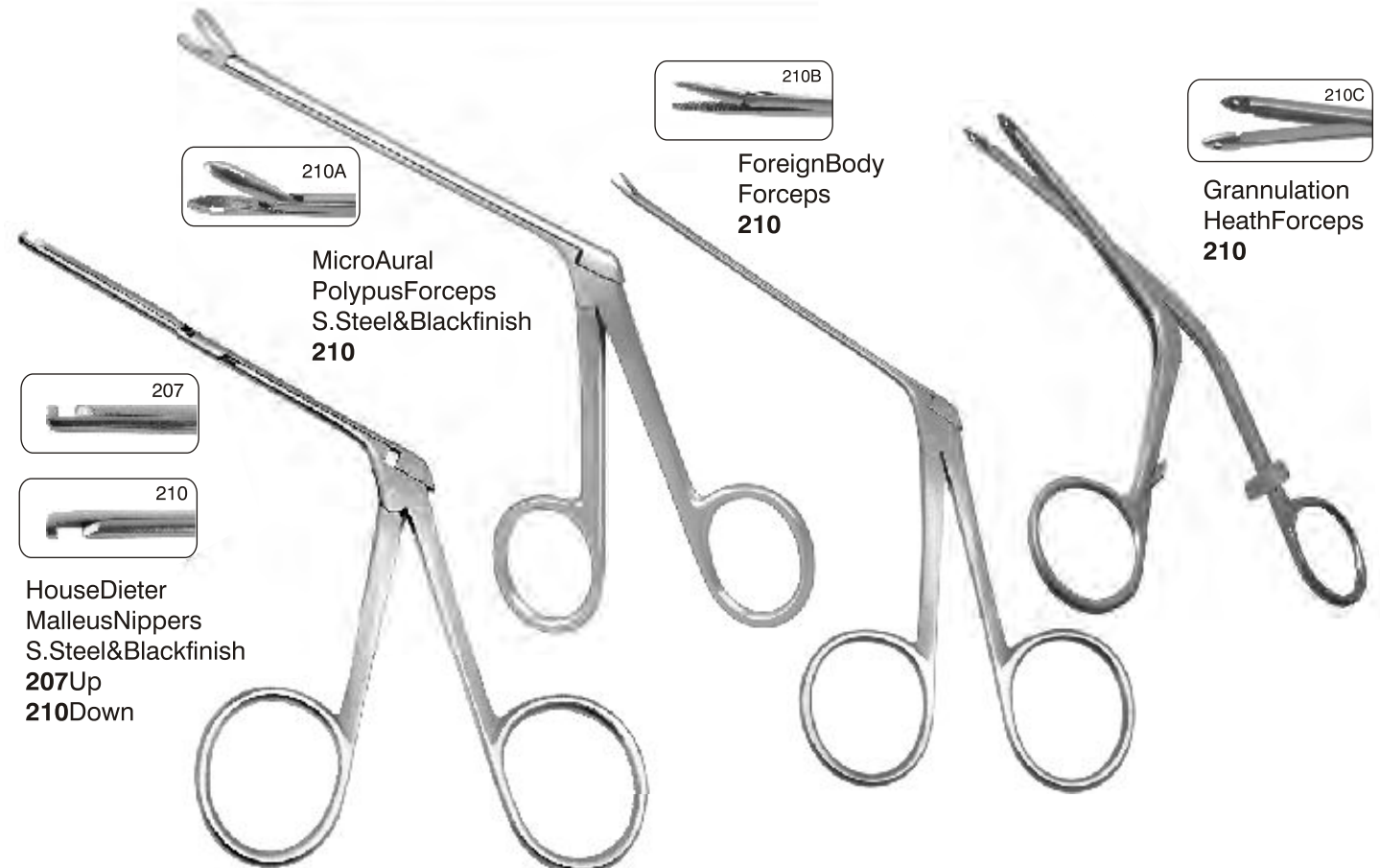
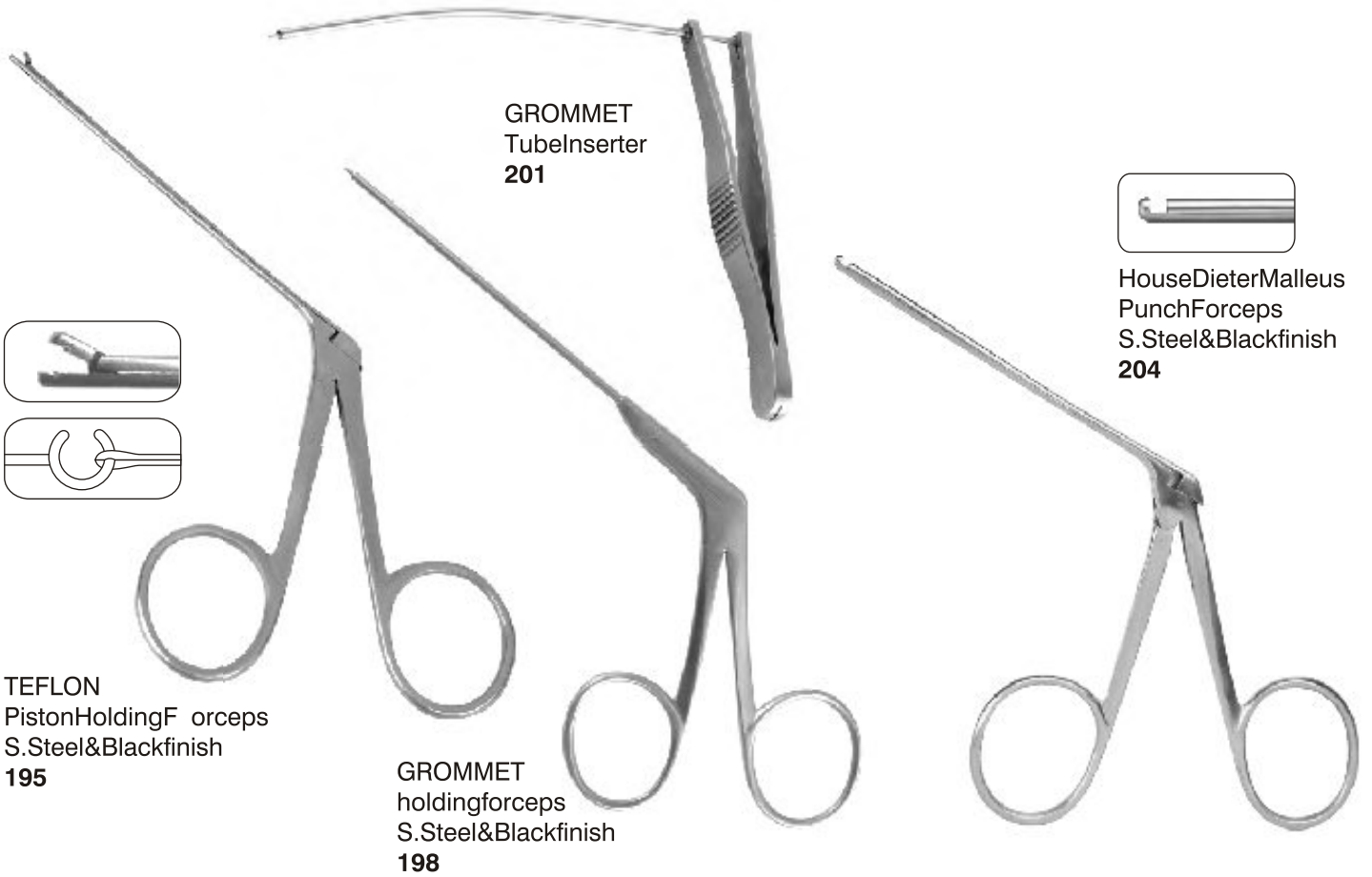



(Set of 8 Instruments)

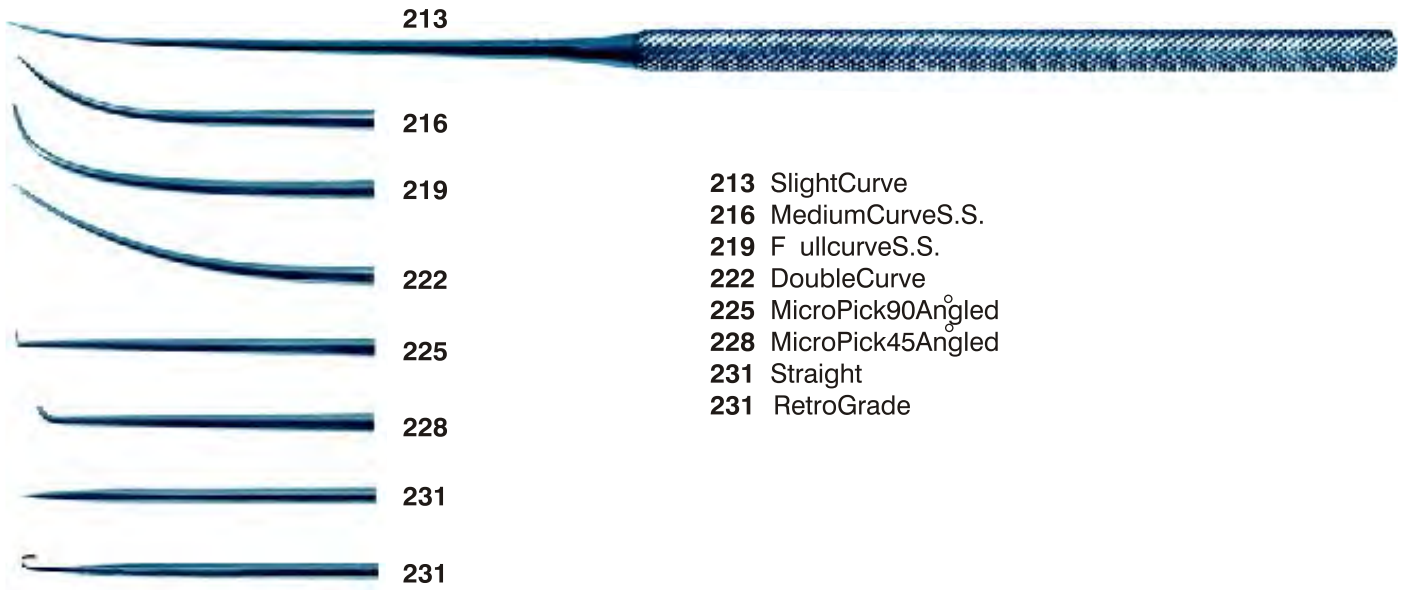

- 213 SlightCurve
- 216 MediumCurveS.S.
- 219 FullCurveS.S.
- 222 DoubleCurve
- 225 MicroPick90Angled
- 228 MicroPick45Angled
- 231 Straight
- 231 RetroGrade

(Set of 9 Instruments)

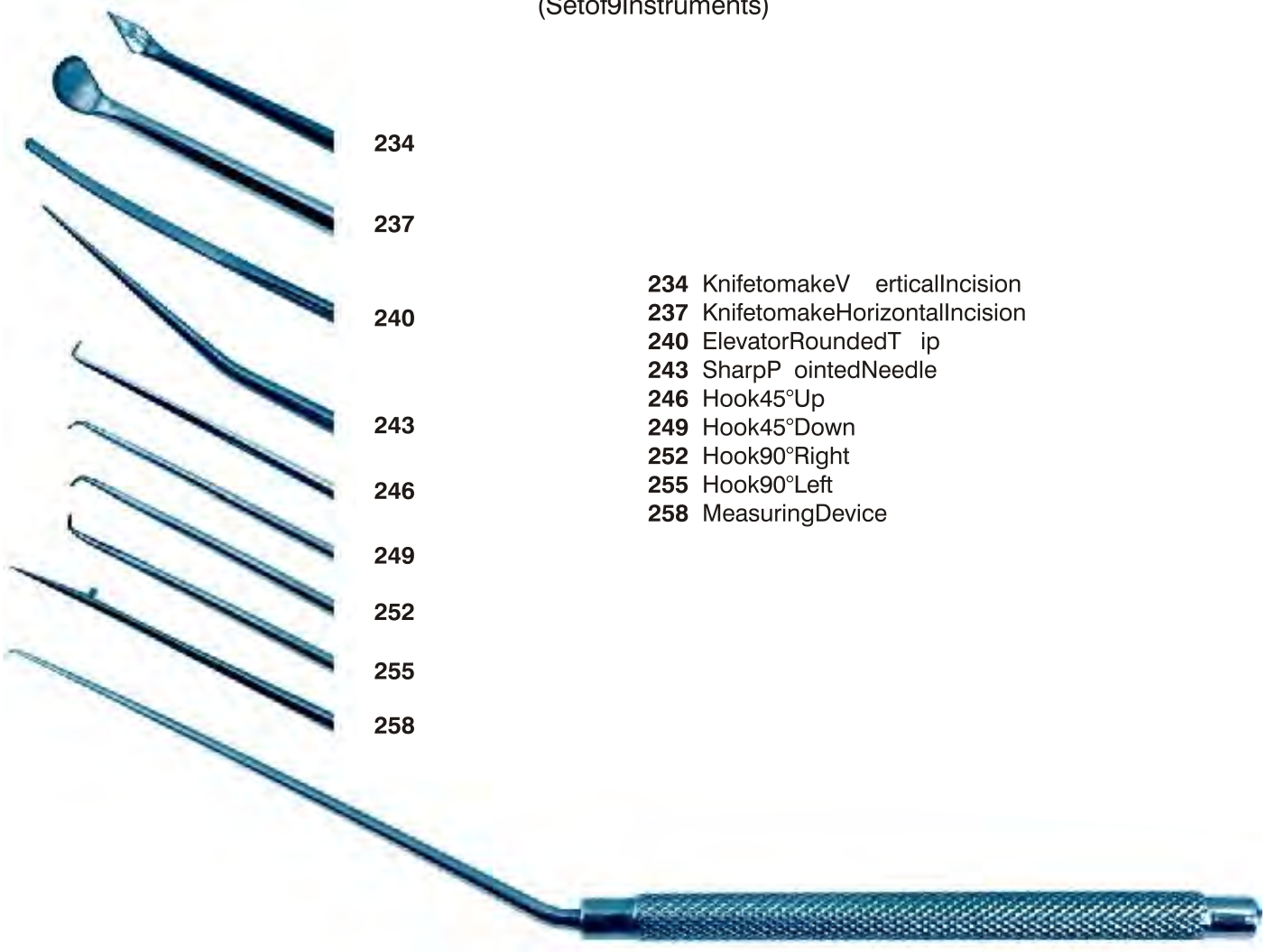

- 234 KnifetomakeVerticalIncision
- 237 KnifetomakeHorizontalIncision
- 240 ElevatorRoundedTip
- 243 SharpPointedNeedle
- 246 Hook45°Up
- 249 Hook45°Down
- 252 Hook90°Right
- 255 Hook90°Left
- 258 MeasuringDevice



(Set of 11 Instruments)

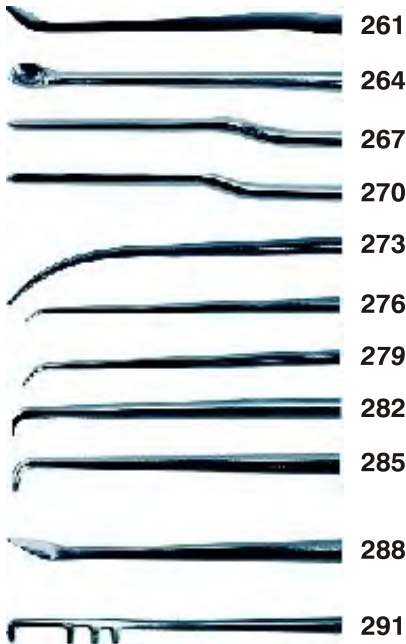

- 261 Incising Knife angular shaft
- 264 Curette Straight
- 267 Elevator Straight-Shaft Left
- 270 Elevator Straight-Shaft Right
- 273 Curved Needle
- 276 Fenestra Hook Straight Shaft 25° angle
- 279 Fenestra Hook Straight Shaft 45° angle
- 282 Fenestra Hook Straight Shaft 90° angle
- 285 Fenestra Hook Straight Shaft 90° angle short
- 288 Anterior Crurotomy Knife Straight Shaft
- 291 SHEA Piston Depth Gauge 3.5mm, 4mm & 4.5mm

(Set of 7 Instruments)

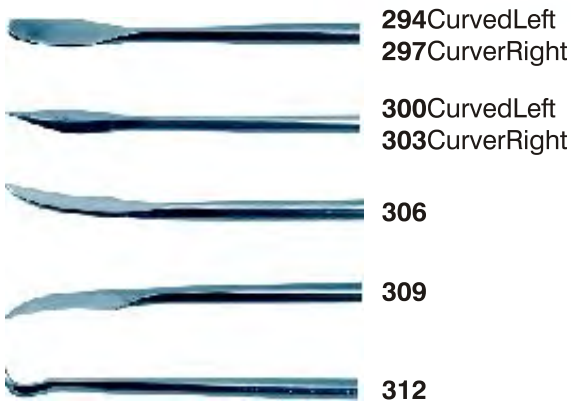
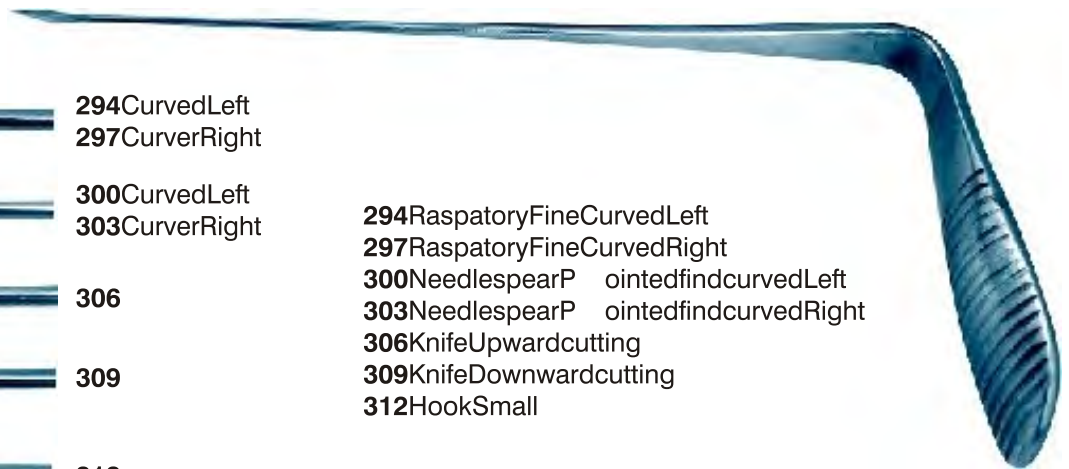

- 294 Raspatory Fine Curved Left
- 297 Raspatory Fine Curved Right
- 300 Needlespear Pointed fine curved Left
- 303 Needlespear Pointed fine curved Right
- 306 Knife Upward cutting
- 309 Knife Downward cutting
- 312 Hook Small

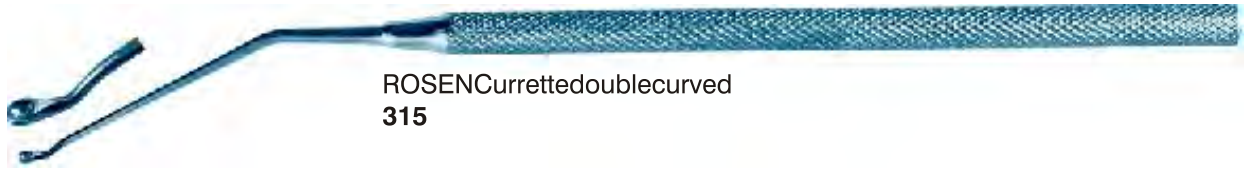

ROSEN Curretted double curved
315

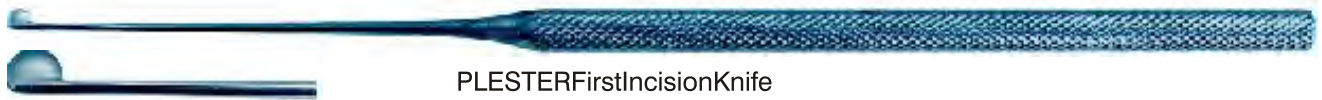

PLESTER First Incision Knife
318



SICKLE Knife
321



BEALES Raspatory
324



MYRINGOTOMY Knife
327



Circular Cutting Knife 60°
330



Circular Cutting Knife curved
333



LARKIN Penetrator (Burr)
336



LARKIN Hand Trepine
339



Plestefirstincisionknife 360°Rotatable
342



ROSENElevatorBayonet
345



ROSENElevatorforLiftingDrum
348



WallsteinNeedle
351 Wallsteinstraightneedlesharp&blunt
351 Wallsteinneedlecurvedsharp&blunt
351 Wallsteinneedlestrongcurvedsharp&blunt



ROSENCuretteCurved StraightShaft
354



ROSENOvalW indow
354



ROSENElevatorGentlycurved
357



ROSENCurette
360



LARKINPerforator
363



DR.KIRTANPerforatorwithGuard
363



House Measuring Rod
3.5, 4.0, 4.5mm
366

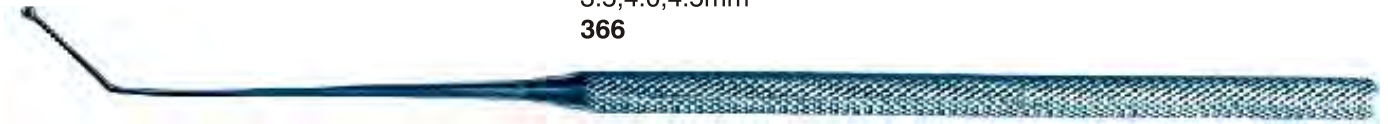

Hook Ball end bent 45°
369



House Curreted double ended
372



House Curreted double ended
372 Slightly curved
372 Fully curved



Cutting Burs
0.6 to 7.0mm
375

Polishing Burs
0.6 to 7.0mm
378

Diamond Burs
0.6 to 7.0mm
381



Hanging Drill with Cable and
Footswitch, Speed 18000 RPM
384



Burrs
Stand Block
384



Micro Instrument Case
with Silicon mat
387

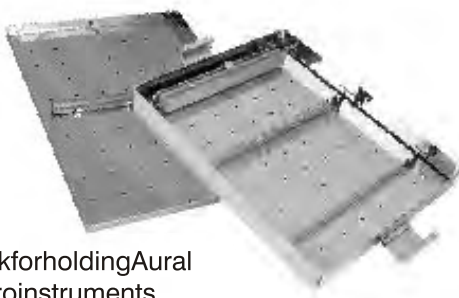

Rack for holding Aural
Micro Instruments
393

Micro Instrument Case with
double Silicon mat Large
390

Micro Instrument Case with
single Silicon mat and rack for
holding Aural Micro Instruments
390





RHINOLOGY / RHINOPLASTY



PILCHER
Nasal Speculum
399



KILLIAN Nasal Speculum 5cm,
6.5cm, 7.5cm, 9cm
402



HARTMANN Nasal Speculum
39mm
402



ST. CLAIR THOMSON
Nasal Speculum
405



THUDICHUM
Nasal Speculum
408



KILLIAN
Nasal Speculum
with fiberoptic
light carrier
411



COTTLE
Retractor Blunt
414



COTTLE
Retractor Sharp
417



GILLIES
Skin Hook Small
420



COTTLE
Upper Lateral
Exposing Retractor
420



ALAR Retractor
423

ALAR hook
double ended
one side blunt
other side sharp
length 12cm
423



KILNER Retractor
426



**PARANASAL
WILLSON Retractor**
429



Micro Retractor
432



HOWARTH Elevator
435



**FREER Elevator
Double ended**
438



**MASSING Elevator
with graduation**
441



**COTTLE Elevator
slightly curved**
444



**COTTLE Elevator
flat board**
444



**SMR Elevator
one side straight
one side curved**
447



PARKER Elevator
450



RHINOLOGY / RHINOPLASTY



JOSEPH
Nasal Elevator
453



Suction elevator
with stilet
456



Tilley LICHTWITZ
Antral Trocar
459



Antral Wash
Rubber Syringe
459



SMR Elevator
462



SMR Fine Elevator
465



HEYMANN
Turbinectomy Scissors
468



HEYMANN Turbinectomy
scissors angle shape
468



KRAUSE
Nasal Snare
471



BALLENGER
Swivel Knife
Bayonet
474



KILLIAN
Nasal Gauge
477



TILLEY Septum
Gauge V Sharp
Cutting Edge
480



FOMAN
Angular Scissors
483



COTTLE
Septal Scissors
Angular Bows
486



LUC Nasal
Turbinate Forceps
small
489



LUC
Nasal Turbinate Forceps
Oval/Small/Large
492



ZOELLNER
Suction Tube
495



FERGUSON
Suction Tube 12/14FR
498



LEMPERT Suction and
Irrigation Tube 1-4
498



WALTERS Scissors
Micro Angle to Side
501



RHINOLOGY / RHINOPLASTY



POTT Angled Scissors
30°, 45°, 60°
501



HEATH Suture
Removal Scissors
501



FOMAN
Upperlateral Scissors
504



Fine Dressing Scissors
Straight/Curved
507



KNAPP
Scissors Curved
510

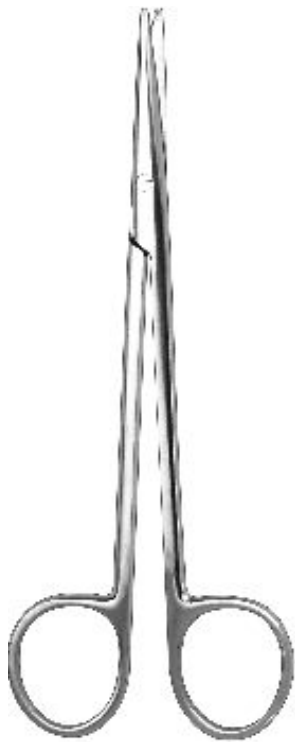

KNAPP
Scissors Straight
513

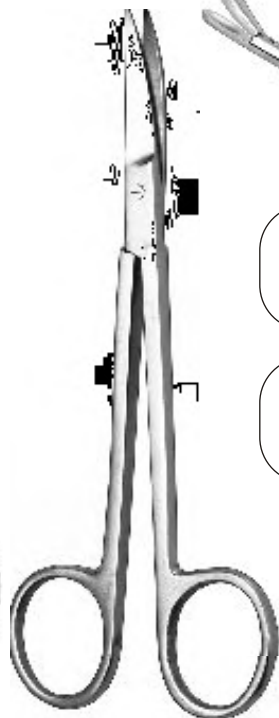

JOSEPH
Scissors St/Cvd
516



519



522



ST. BARTHOLOMEW Punch
519 Straight
522 Upward

Skin Biopsy Punch
Forcep
525





Dr.V.P.SoodLove
Retractor
528



WATSONWILLIAM
NasalPolypusForceps
531



WAUGH
DissectingForcep
FineSerrated15cm
534



WAUGH
DissectingForcep
Fine1x2teeth,15cm
537



Septum
CuttingForceps
540



Septum
cuttingForceps
double action
540



WALSHAMSeptum
StraighteningForceps
543Left
546Right



WALSHAMSeptum
StraighteningForceps
549



ASHSeptum
Straightening
Forceps
552



SeptumMorcelizer
DoubleActionstraight
555



RHINOLOGY / RHINOPLASTY



Septum
Morcellizer Double
Action Forceps Angled
555



Septum
Crusing Forceps
555



Septum
Cutting Scissors
555



TILLEY
Harpoon
Trocar
558



MYLES
NesoAntral
Perforator
561



TILLEY
Antrum Burs
564

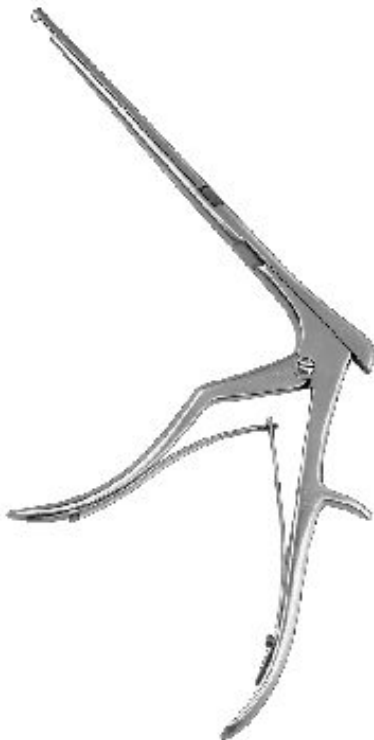

KERRISON Punch
length 140mm
567 Upward Cutting
567 Downward Cutting



AUFRIGHT
Nasal Retractor
570 Right



AUFRIGHT Nasal
Retractor with Fibre
optic light carrier
570



Nasal
Retractor
570



CHEEK
Retractor
570



Nasal
Osteotome
6,8,10,12mm
573



Silver Chisel
576 Straight
579 Right
582 Left



JENKING Gauge
3 to 12mm
585



GILLIES Gauge
3,4,6,8,10,12mm
588



Mallet
591



GILLIES
Chisel
594



Osteotome
597



Measuring
Osteotome
2,4,6,8mm
597



MALTZ Rasp
600



AUFRICHT
Nasal Rasp
603



JOSEPH
Nasal Rasp
Fine
606

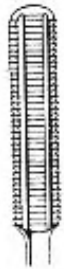

JOSEPH Nasal
Rasp curved
606



JOSEPH Nasal
Rasp fine
double ended
609



JOSEPH
Nasal Saw
612 Right
615 Left



Caliper
618



RHINOLOGY / RHINOPLASTY



KNAPP Columnella
Forcep
621



Wire Cutting Scissors
624



HUMBY Skin Graft Knife
Long & Small
627



LACRYMAL Probe
Beroman D/E Size: 1-8
627



Pigtail Probe
with Suture
Hole D/E
627



Micro Needle
Holder with Lock
castroviejo St./Cvd.
627



Needle Holder
Barraquer
St./Cvd
627



Frontal
Sinus Bougies
627



Spring Scissors
St./Cvd./Angled
627



Catpaw
Retractor
627



Lacrimal
Dialator
627



Lacrimal
Intubation set
(stent)
627

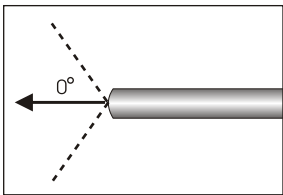

Straight Forward Wide
Angle Sinuscope 0° 4mm
Length 185mm
630

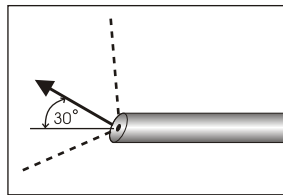

Forward Oblique Wide
Angle Sinuscope 30° 4mm
633

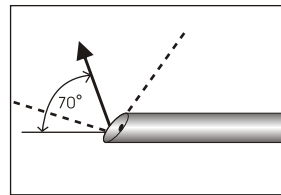

Lateral Wide Angle
Sinuscope 70° 4mm
636



Telescope handle
round, 11cm length
636
636 Flat handle



Trocar & Cannula
for Sinuscopy,
O.D. 5mm, Length
of Cannula 8.5cm
639



V. EICKEN Antrum
Cannula 15cm
Long Curved
642



V. EICKEN
Killian Antrum
Cannula
642



ANTRUM Monopolar
Suction Tube St./Cvd.
642



Suction Irrigation
Tube with Channel
for inflow & outflow
645



FRAZIER
Suction Tube
12/14FR
648



SINUSCOPY



Massing Elevator
Graduated
651



ANTRUM Curette:
654 Oval 19cm
with Suction
654 oblong, small size
55 °curved, 90°curved



ANTRUM Curette 19cm
657 backward cutting
657 with suction



ANTRUM Curette
19cm forward cutting
660



Paranasal Curette
Double ended
663

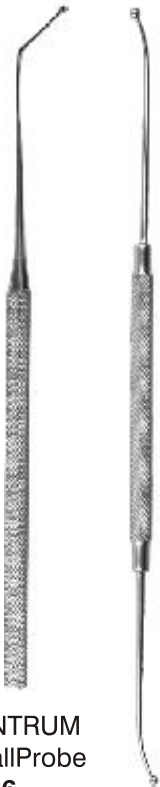

ANTRUM
Ball Probe
666



ANTRUM Ball Probe
Slightly curved
double ended
666



Frontal Sinus
Seeker
double ended,
curved 90°,
one tip straight,
one tip reverse
angled
length 22cm
666



Sickle Knife 19cm
669 Pointed tip
669 Blunt tip



Sinus
Scissors
669



Sinus Dressing
forceps serrated,
working length 9.5cm
669

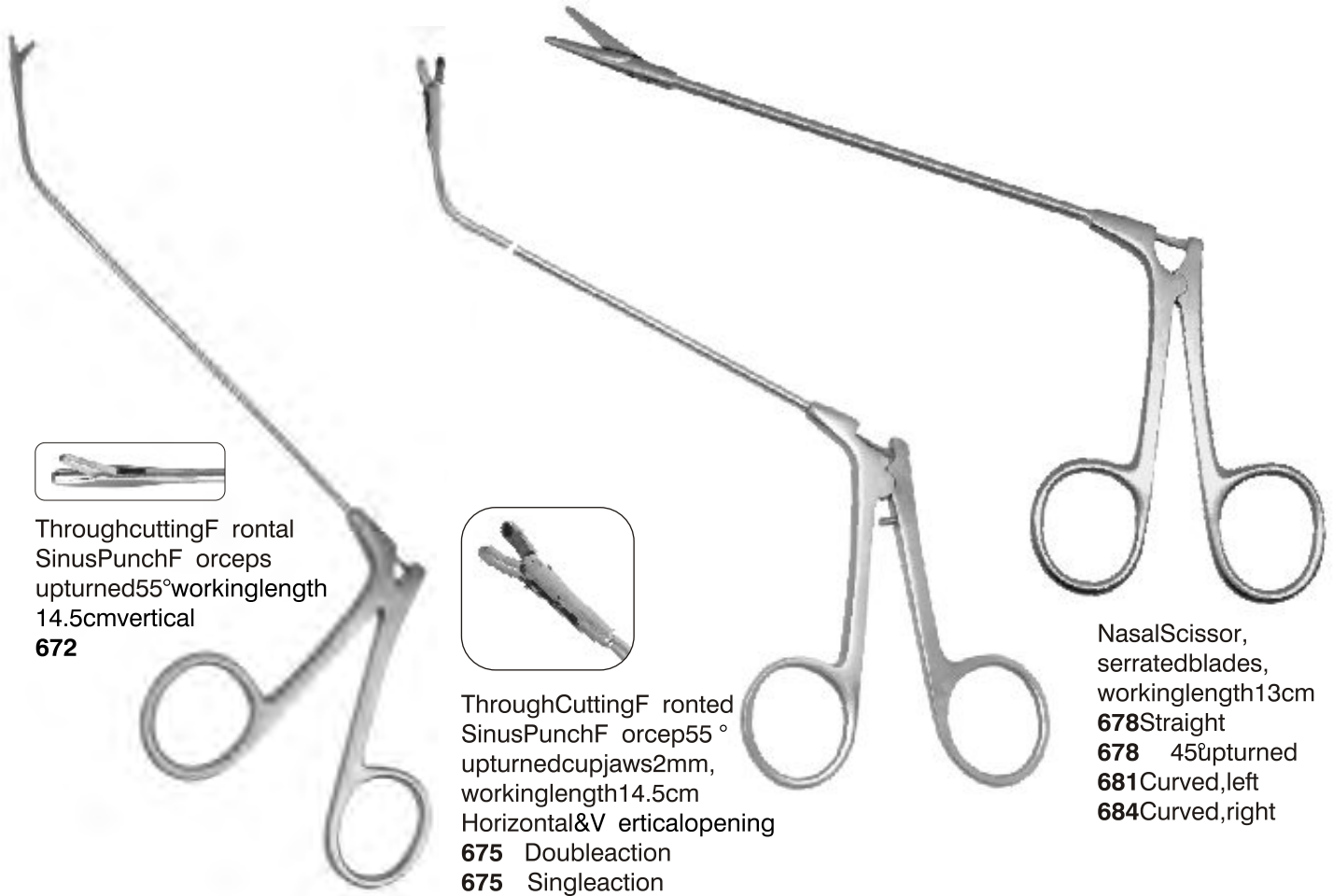

ThroughcuttingF rontal
SinusPunchF orceps
upturned55°workinglength
14.5cmvertical
672



ThroughCuttingF ronted
SinusPunchF orcep55°
upturnedcupjaws2mm,
workinglength14.5cm
Horizontal&V erticalopening
675 Doubleaction
675 Singleaction

NasalScissor,
serratedblades,
workinglength13cm
678 Straight
678 45°upturned
681 Curved,left
684 Curved,right

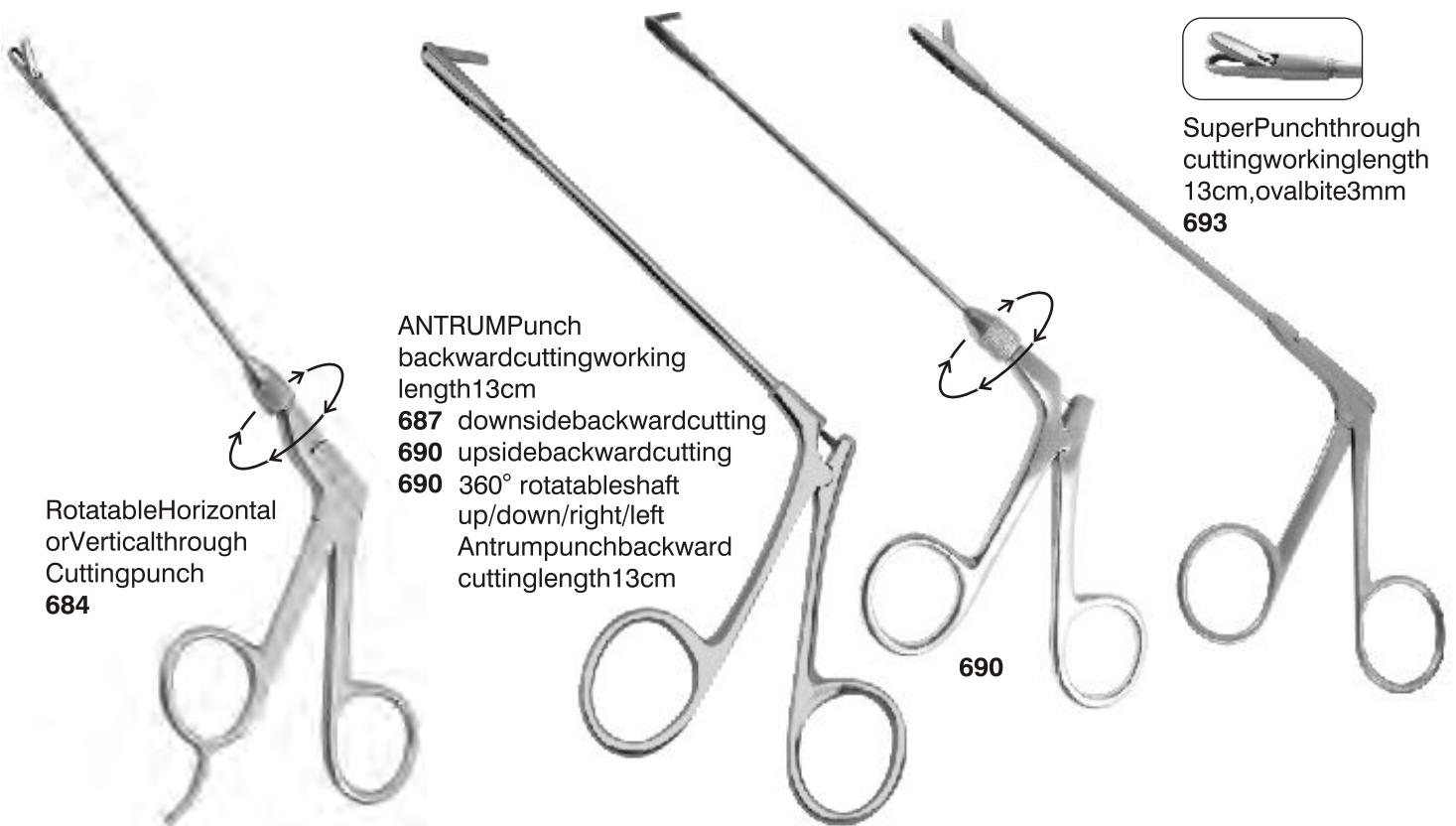

SuperPunchthrough
cuttingworkinglength
13cm,ovalbite3mm
693

RotatableHorizontal
orVerticalthrough
Cuttingpunch
684

ANTRUMPunch
backwardcuttingworking
length13cm
687 downsidebackwardcutting
690 upsidebackwardcutting
690 360° rotatableshaft
up/down/right/left
Antrumpunchbackward
cuttinglength13cm

690



SINUSCOPY

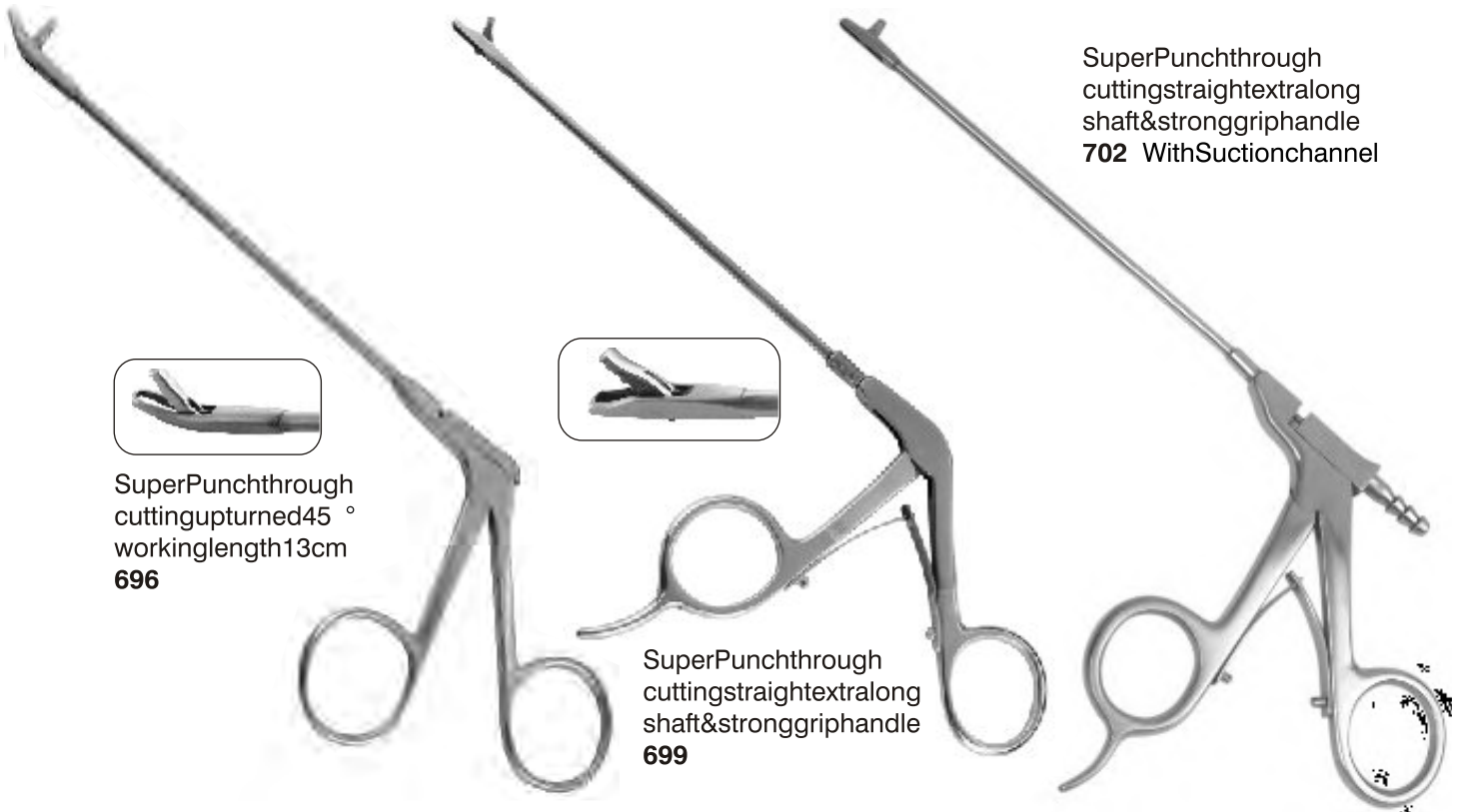

SuperPunchthrough cuttingupturned45 ° workinglength13cm
696



SuperPunchthrough cuttingstraightextralong shaft&stronggriphandle
699

SuperPunchthrough cuttingstraightextralong shaft&stronggriphandle
702 WithSuctionchannel

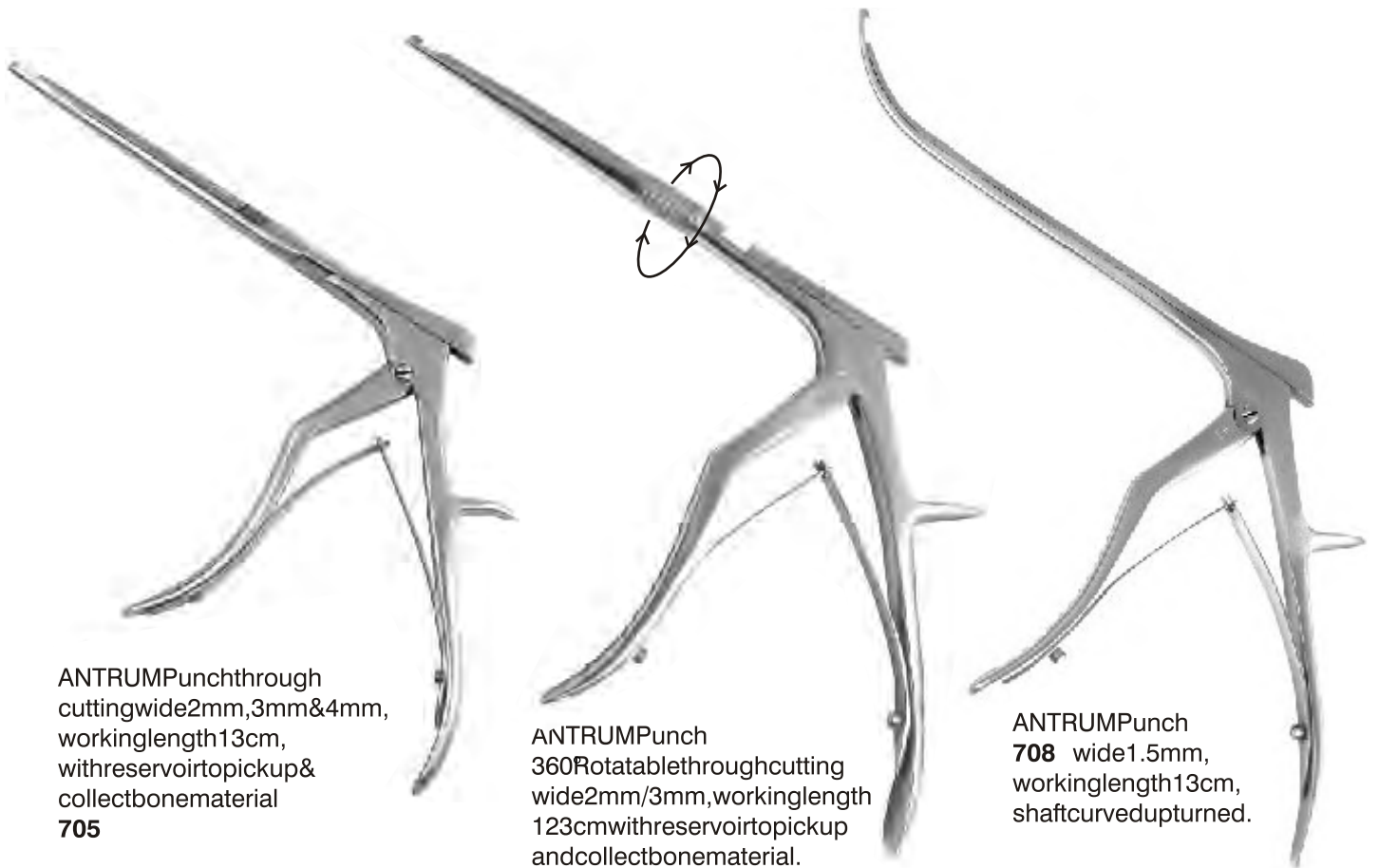

ANTRUMPunchthrough cuttingwide2mm,3mm&4mm, workinglength13cm, withreservoirtopickup& collectbonematerial
705

ANTRUMPunch 360Rotatablethroughcutting wide2mm/3mm,workinglength 123cmwithreservoirtopickup andcollectbonematerial.
708

ANTRUMPunch **708** wide1.5mm, workinglength13cm, shaftcurvedupturned.

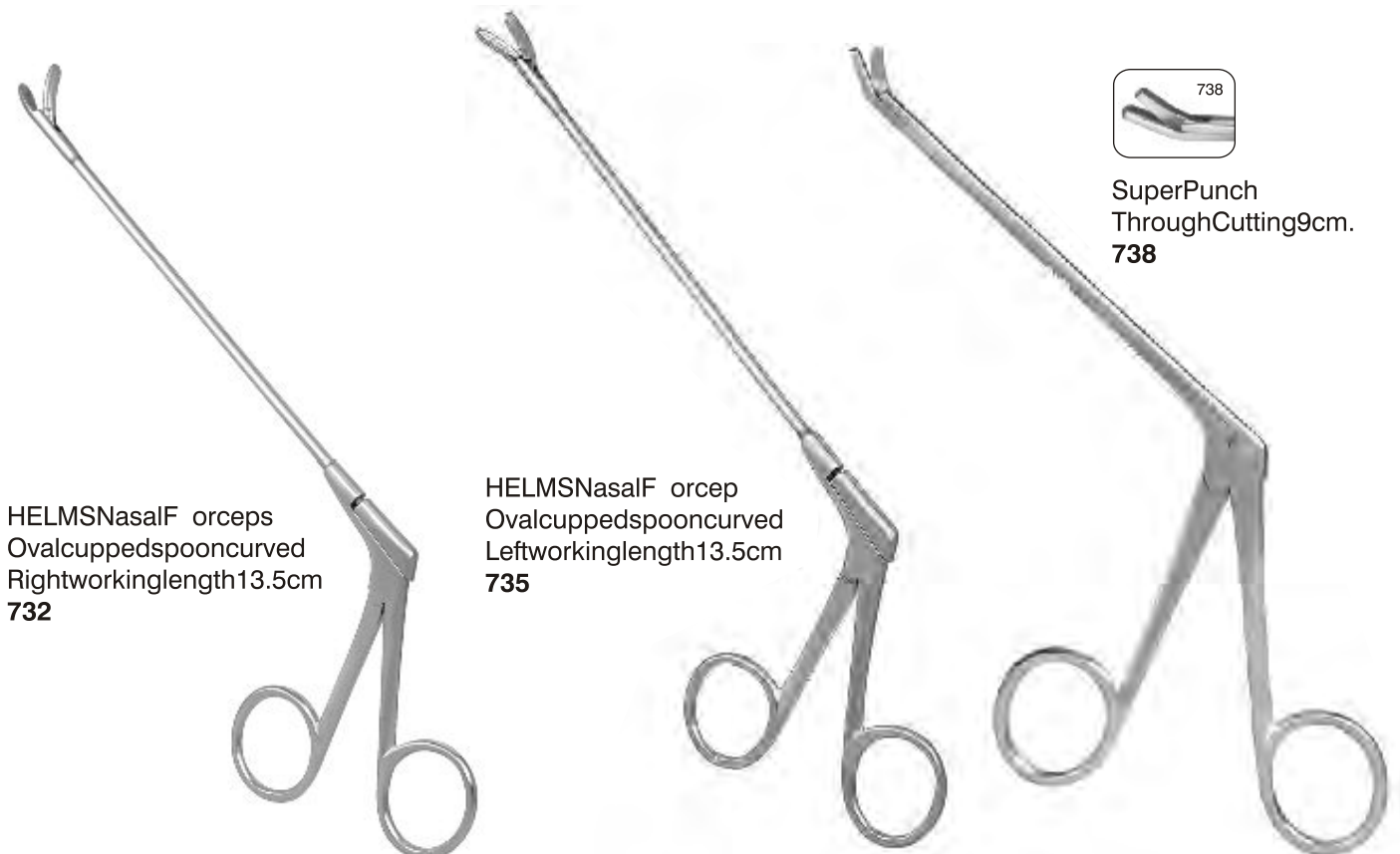
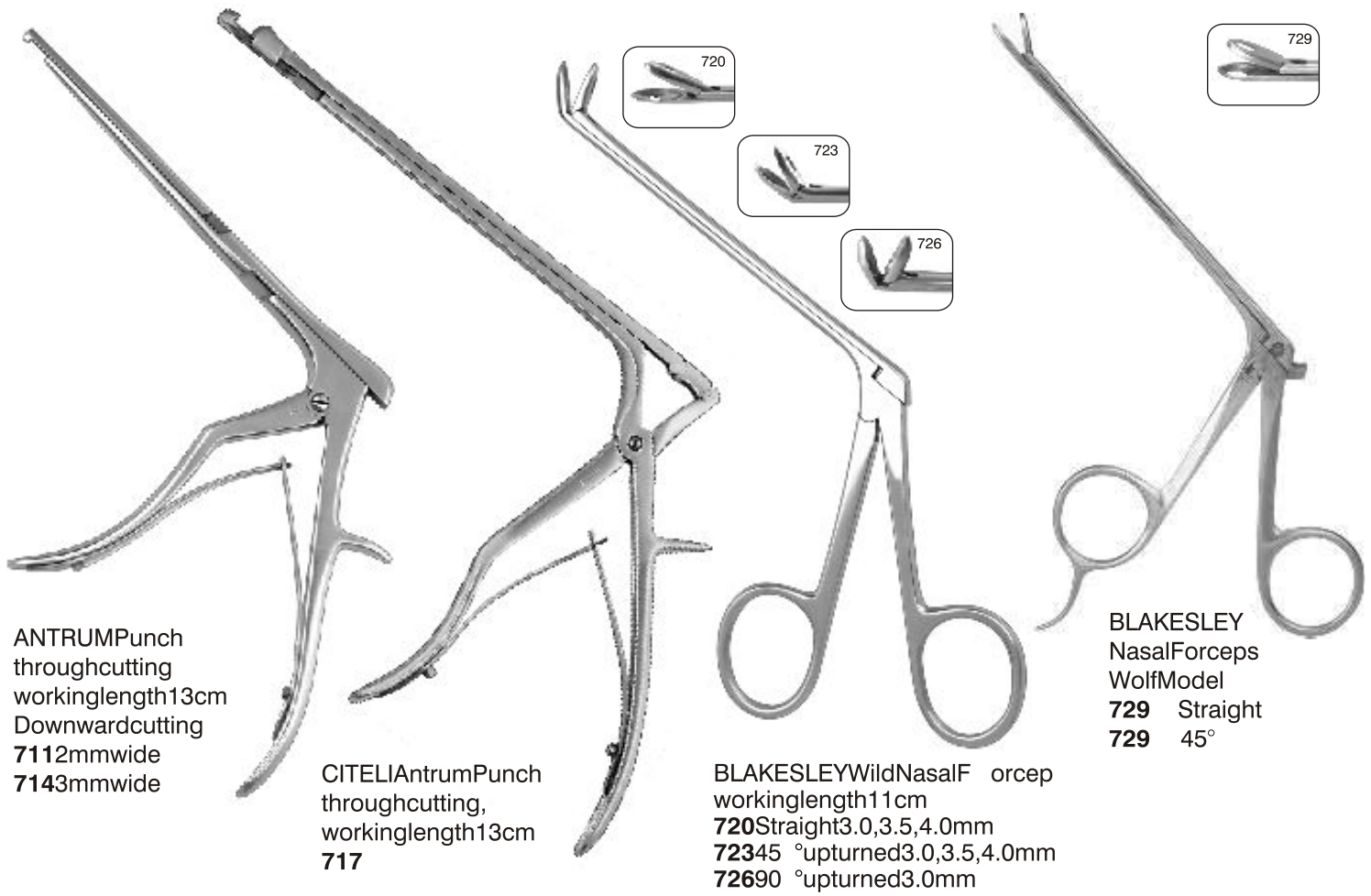



SINUSCOPY



BLAKESLEY
Suction Forcep with integrated
suction channel upturned
744

ANTRUM suction Backbiter
with integrated suction
channel upside backward
cutting
747

BLAKESLEY Suction Forcep
with integrated Suction
Channel Straight
741
741 45° upward

741

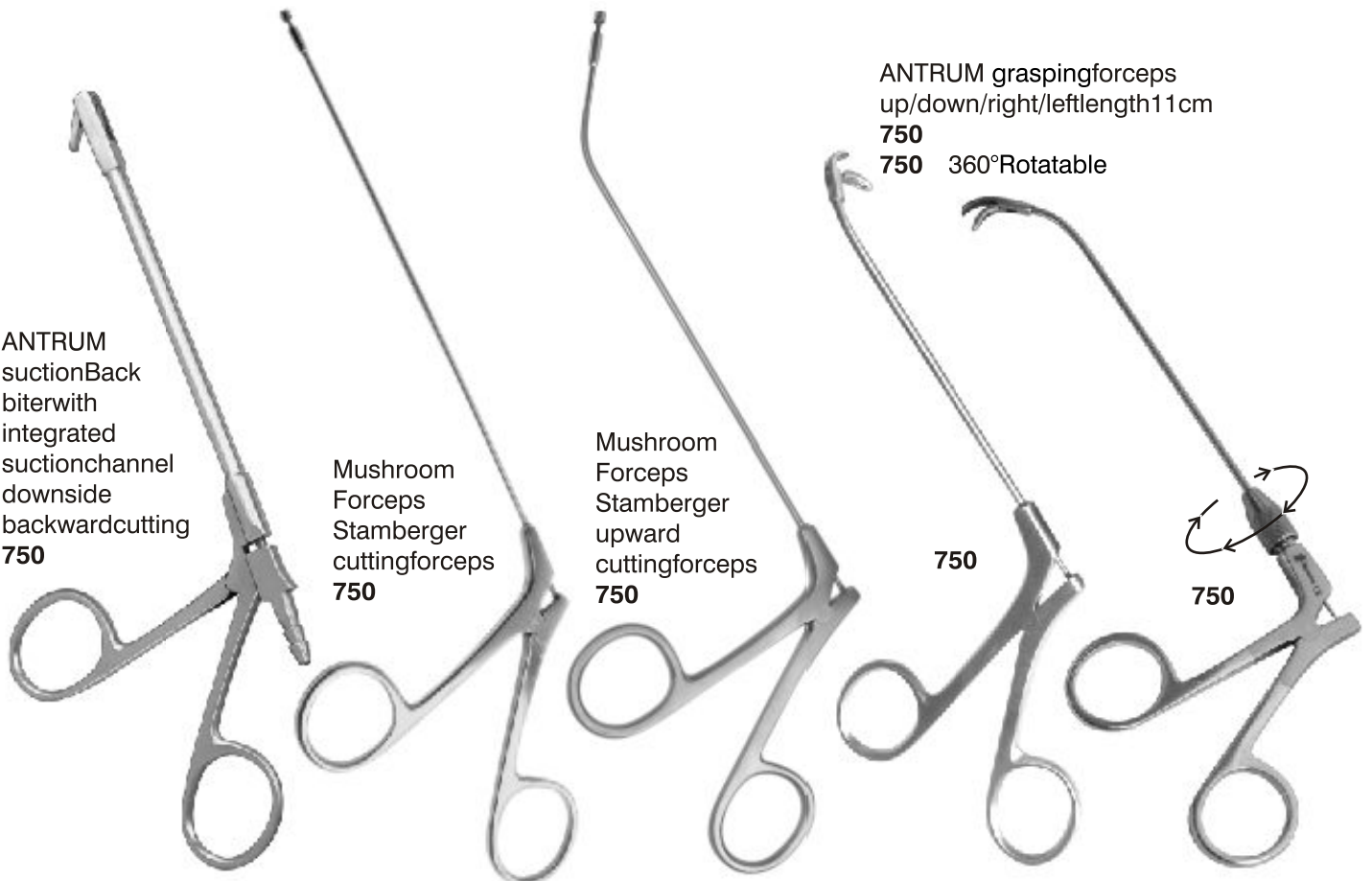

ANTRUM
suction Back
biter with
integrated
suction channel
downside
backward cutting
750

Mushroom
Forceps
Stamberger
cutting forceps
750

Mushroom
Forceps
Stamberger
upward
cutting forceps
750

ANTRUM grasping forceps
up/down/right/left length 11 cm
750
750 360° Rotatable

750

750





TongueDepressor
Setof3
753

BIRKETTonsil
ArteryForcep
756Straight

BIRKETTonsil
ArteryForcep
759Curved

NEGUSTonsil
ArteryForcep
762AccurateCurved

NEGUSTonsil
ArteryForcep
VShapedCurved
765

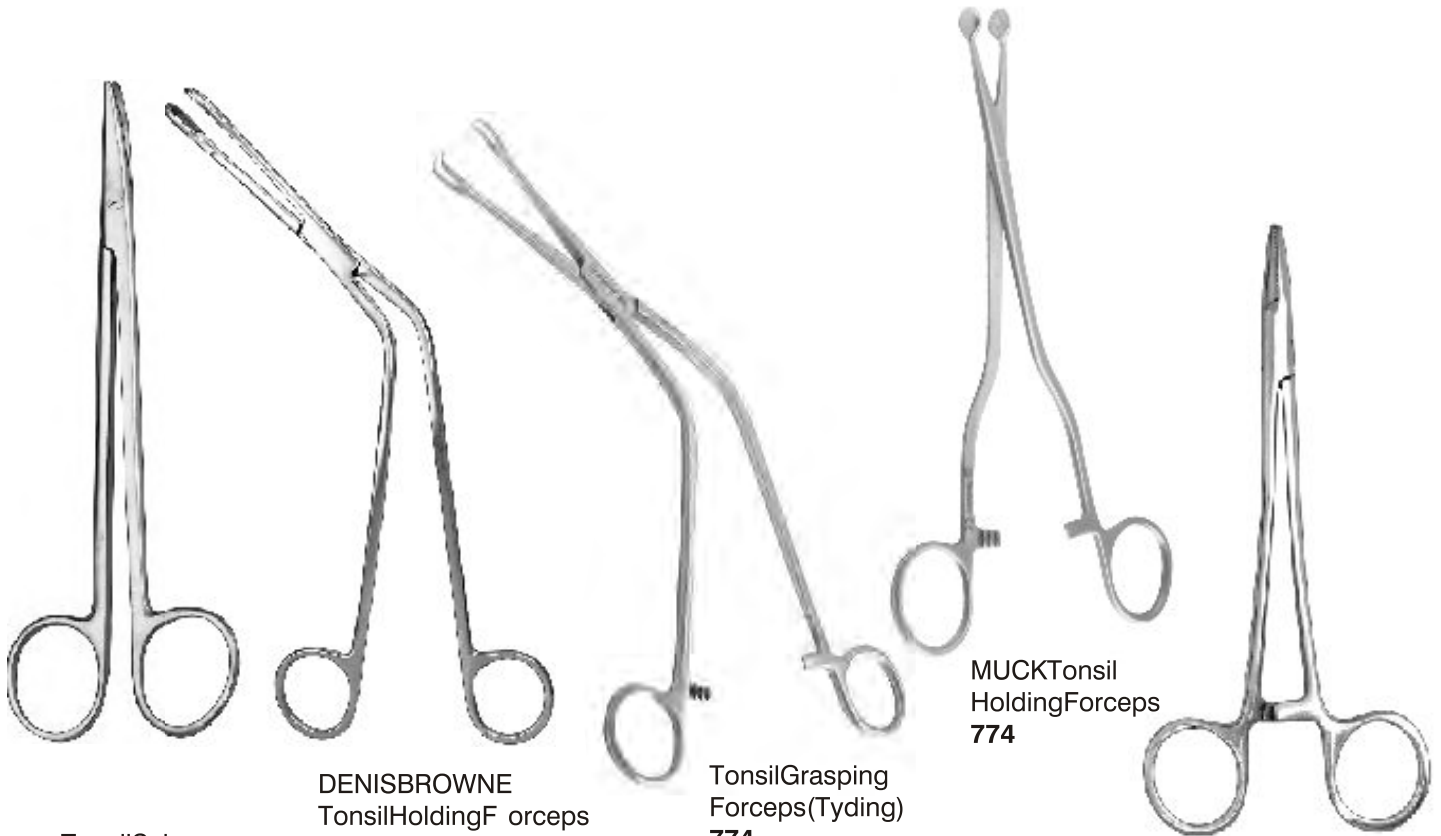

TonsilScissor
771 Straight
771 Curved

DENISBROWNE
TonsilHoldingF orceps
774

TonsilGrasping
Forceps(Tyding)
774

MUCKTonsil
HoldingForceps
774

TonsilNeedleHolder
777Size-4",5",6",7",8"



TONSILLECTOMY



Tonsil Needle Holder
T.C. Coated tip 4", 5", 6", 7"
780



Kilner
Needle Holder
780



Peritonsillar Forceps
783



EVETonsil Snare
786



IRWINMOORE
Tonsil Needle
Right & Left
789



Tonsillar Knife
792



HANKETonsil Dissector
one side serrated
795



HURDTonsil Dissector
& Pillar Retractor
798



Tonsillar Pillar Retractor &
Dissector serrated fine
801



Tonsil Dissector
for child
804



NEGUS
Pusher Knot Tier
807



Tongue
Tie Probe
810



YANKAUER
Tonsil Suction Tube
813



WAUGH
Tonsil Dissecting Forceps
816



WAUGH Tonsil Dissecting
Forceps 1x2 teeth
819



HEISTER
Mouth Gag
822



JENNINGS
Mouth Gag
825



DOYEN'S
Mouth Gag
Adult & Child
825



BACKMANN
Adenoid Curette
828



ST. CLAIR THOMPSON
Adenoid Curette
with cage
831



TONSILLECTOMY

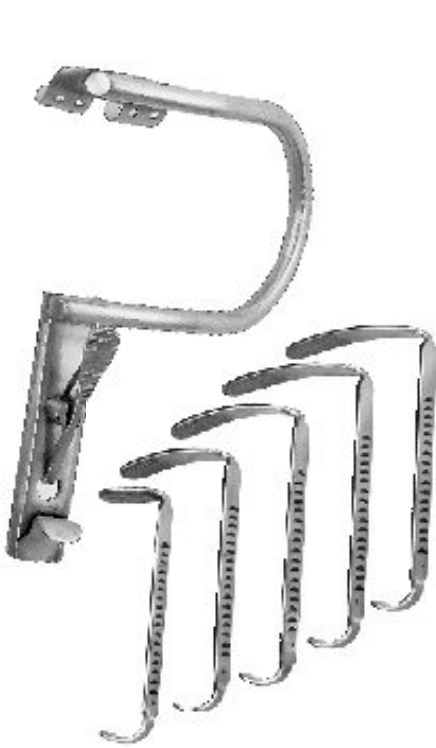

DAVISBOYLEMouth
GagwithT onsilPlates
834 Adult5Blades
834 Child3Blades



DOUGHTYSlottedMouth
GagwithT onguePlates
837 Adult5Blades
837 Child3Blades



DINGMANMouthGag
withTonguePlates
840

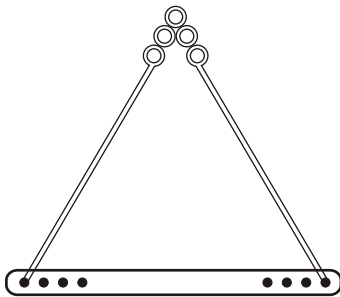

DRAFFINBipodStand
withPlates
843

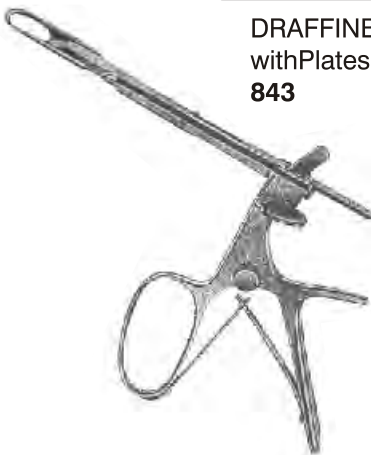

SULUNDER-BALLENGER
Tonsillectome
840 Detachable3Blades



CLOVERTonsil
HoldingForceps
846



TongueHoldingF orceps
849



HARTMANT onsilPunch
852



Laryngeal Mirrors
No: 1-2-3-4-5
855



Post Rhinoscopic Mirror
No: 1-2-3-4-5
858



Mirror Handle
861



BACKHAUS
Towel Forcep
864



Towel Clip
Cross Section
867



MOSQUITO Artery
Forcep Straight Curved
870

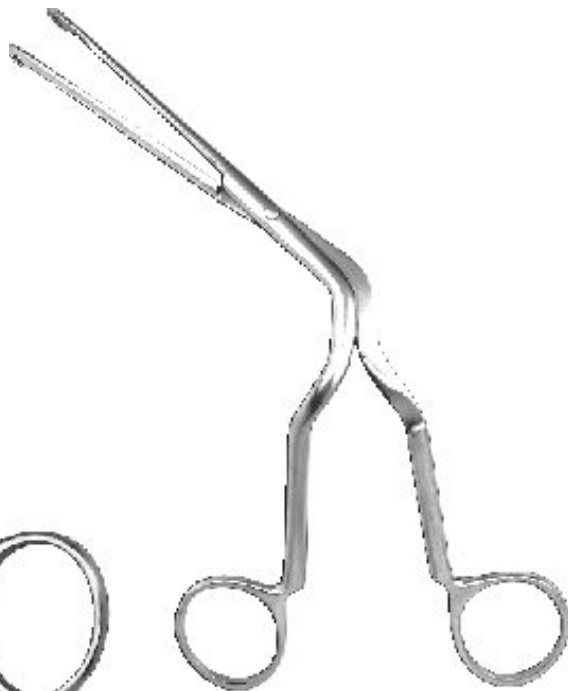

MAGILL Intratracheal
Catheter Forceps
Large/Medium/Small
873



Tracheal
Dilating Forceps
876



LANGENBECK
Retractor
879



LARYNGOLOGY



Tracheal Retractor
2 prong blunt
882



Volkman Retractor
4 prong
882



Tracheal Retractor
1 prong sharp/blunt
885



JACKSON Tracheotomy
Tube all metal
19FG to 42FG
888

FULLER
Tracheotomy Tube
18FG to 36FG
891



BARDPARKER
Handle No: 3, 4, 7
894



MACINTOSH
Laryngoscope
with 4 blades
897



LARYNGOSCOPY-BRONCHOOESOPHAGOSCOPYFORCEPS

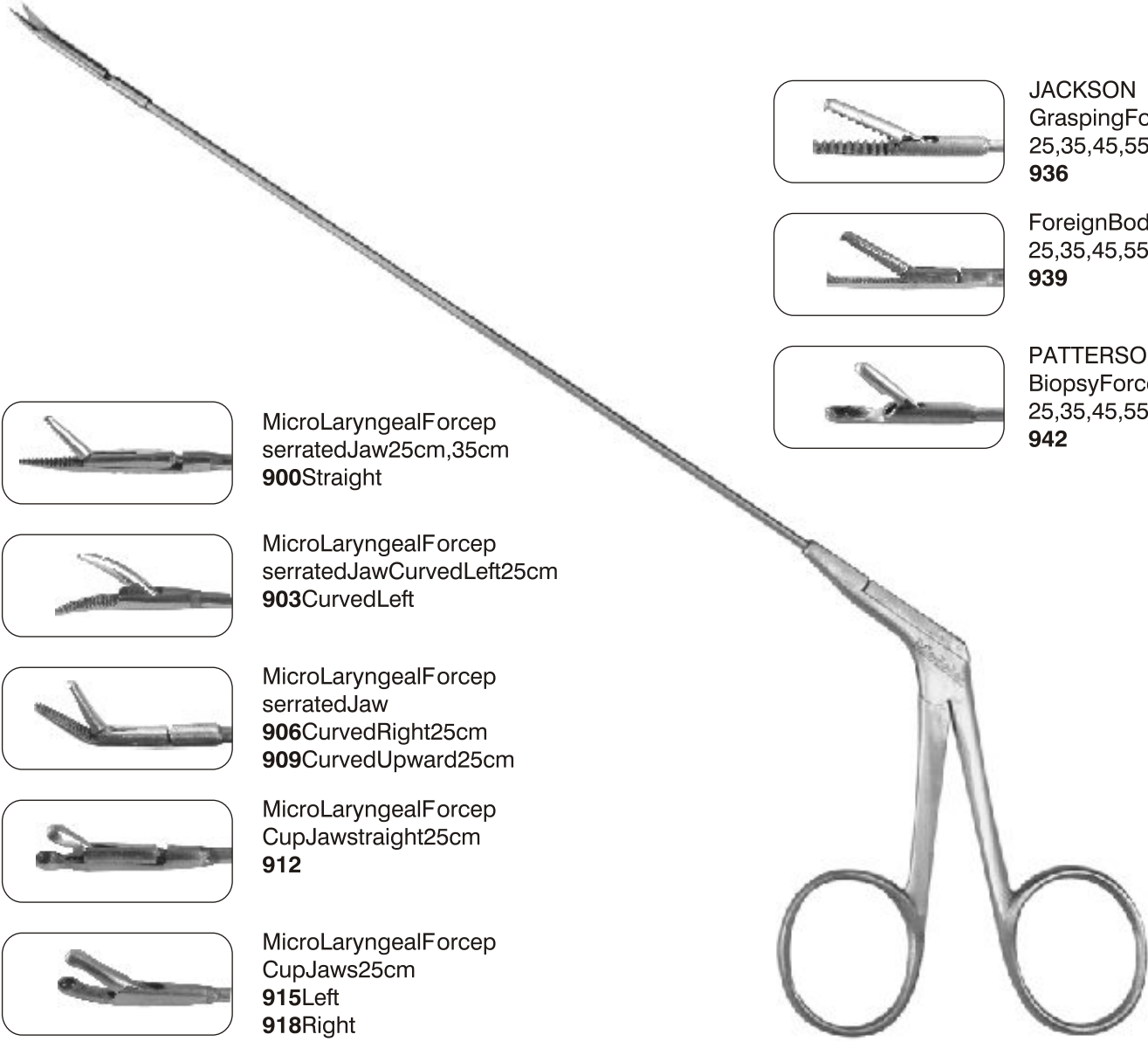

MicroLaryngealForcep
serratedJaw25cm,35cm
900Straight



MicroLaryngealForcep
serratedJawCurvedLeft25cm
903CurvedLeft



MicroLaryngealForcep
serratedJaw
906CurvedRight25cm
909CurvedUpward25cm



MicroLaryngealForcep
CupJawstraight25cm
912



MicroLaryngealForcep
CupJaws25cm
915Left
918Right



MicroLaryngealForcep
CupJawsUpward25cm
921



MicroLaryngealScissors
straight25cm
924



MicroLaryngealScissors25cm
927Left
930Right



MicroLaryngealScissors
Upward25cm
933



JACKSON
GraspingForcep
25,35,45,55cm
936



ForeignBodyF orcep
25,35,45,55cm
939



PATTERSON
BiopsyForcep
25,35,45,55cm
942



BiopsyCupForcep
25,35,45,55cm
945



BiopsyPunchForcep
25,35,45,55cm
948



JACKSON
ForeignBodyForcep
25,35,45,55cm
951



JACKSON
AlligatorForcep
25,35,45,55cm
954



LARYNGOLOGY

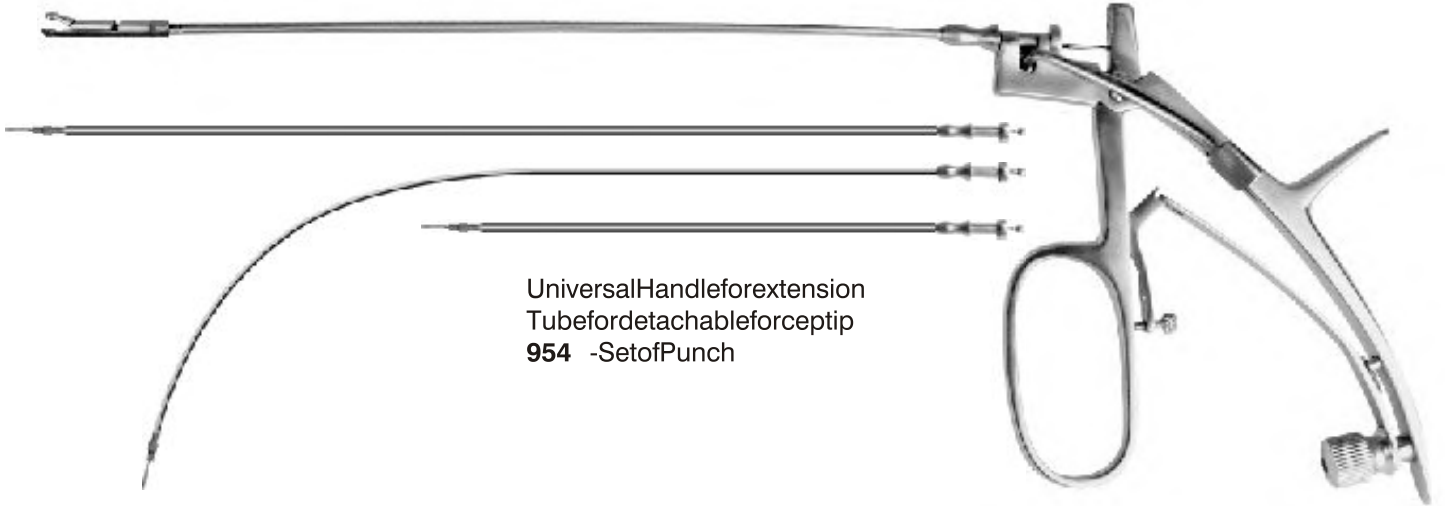

Universal Handleforextension
Tube for detachable force tip
954 -Set of Punch



Laryngeal Suction Tube
25cm, 35cm
957

Bronchoscope
Suction Tube
35cm, 45cm & 55cm
960



MicroLaryngeal
Round Knife 45°
963



MicroLaryngeal
Sickle Knife
975



MicroLaryngeal
Plaster Knife
966



MicroLaryngeal
Hook 45°
978



MicroLaryngeal
Peeling Knife
969



MicroLaryngeal
Ring Straight
981



MicroLaryngeal
Probe 90°
972



MicroLaryngeal
Swab Holder
984 Holder for Micro
Laryngeal Instruments





Anterior Commissure
Laryngoscope with
Fibre Optic Carrier
Small/Med/Large
987



Hypo-Pharyngoscope
with Fibre Light Carrier
Child/Adult
990

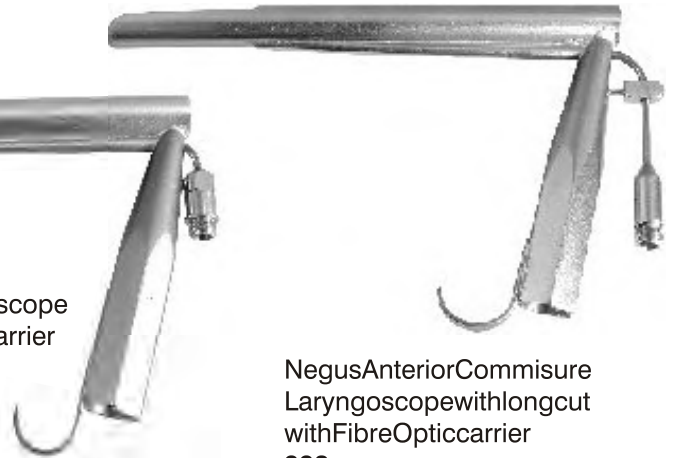

Negus Anterior Commissure
Laryngoscope with long cut
with Fibre Optic carrier
993



JACKSON Laryngoscope
with Fibre Light Carrier
996

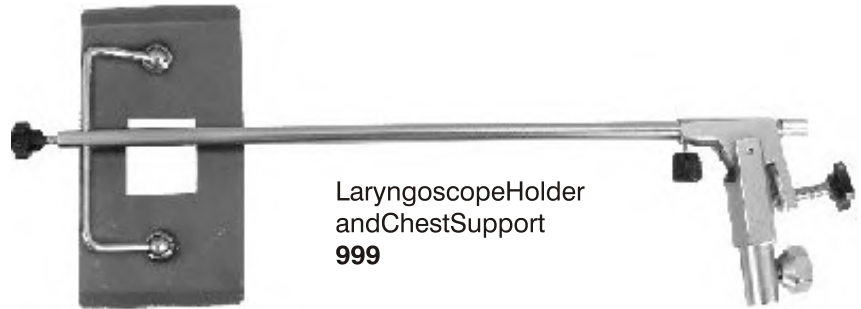

Laryngoscope Holder
and Chest Support
999

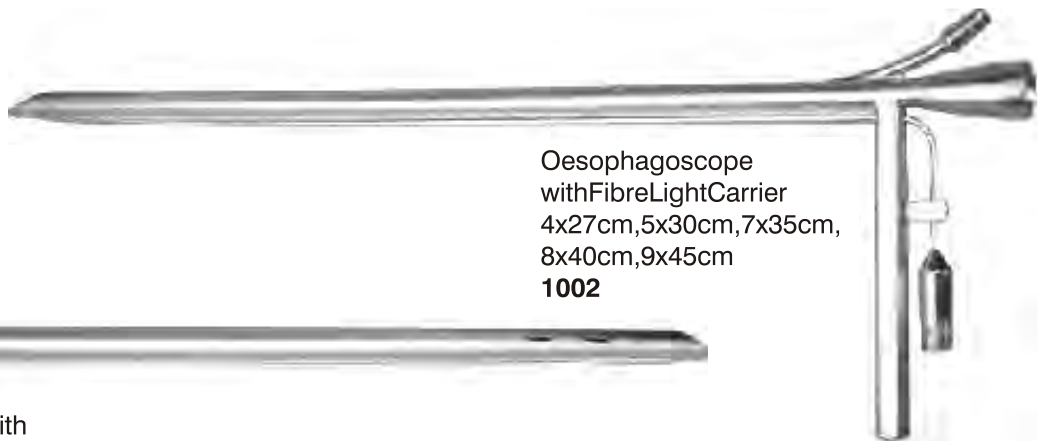

Oesophagoscope
with Fibre Light Carrier
4x27cm, 5x30cm, 7x35cm,
8x40cm, 9x45cm
1002

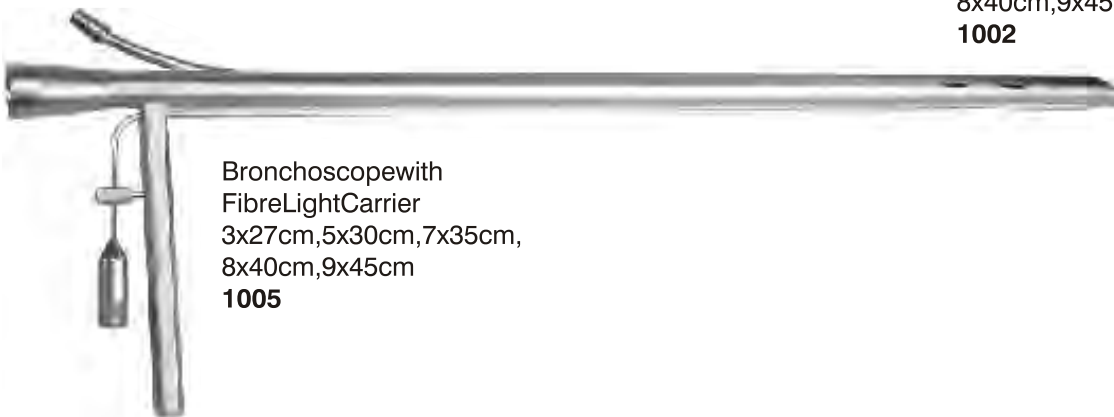

Bronchoscope with
Fibre Light Carrier
3x27cm, 5x30cm, 7x35cm,
8x40cm, 9x45cm
1005



Fibreopticotoscopewithcompactmovablelight sourcefittedwithfullfibreopticcarrier
1008 MadeinChina/Imported



Fibre-OpticBronchoscope"AOHU A"
 Model:ABF -6(FullyImmersible)
 withHalogenColdLightSource(250W att)
 SPECIFICATIONS:
 *AngleOfViewField:85°
 *RangeOfT ipBanding:130U/90D
 *DepthOfView:3-50mm
 *DiameterOfInstrumentChannel:2mm
 *W orkingLength:530mm
 StandardSetOfAccessories
1011 MadeinChina/Imported



NasalPowerDrill
 thispowerdrillusedinENT&Orth
 surgicalproceduresworkin3500RPM
 witheasyaspirationdiffrentspeedlevel
 andfootcontrol
1011 MadeinChina/Imported





Sponge Holding Forceps
2001



Alice Tissue Forceps
2004



Cheatele Forceps
2007



Cheatele Jar
2007



Bipolar Coagulation
Forceps Angled
2010



Bipolar Coagulation
Forceps Straight
2013



Bipolar Coagulation
Forceps Bayonet Type
2016



Atomiser
2019



Porp
2022

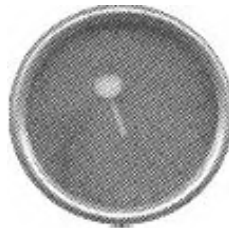

Torp
2025



Grommet
2028



TeflonPiston
2031



2034

Digital image enhancement and digital signal processing for true color reproductions and crisp, clear image quality.

Auto/manual white balance

Auto shutter 1/60-1/10000

adjustable Brightness

470 lines horizontal resolution

Signal to noise ratio 48db

Soakable Camera head

Hi-Di-CCD Camera for Flexible Scopes



2034

The stroboscope examination for basic voice frequency, the sound pressure level, the musical tone pitch and loudness classes are shown.

Optional: Computerized Digital Model

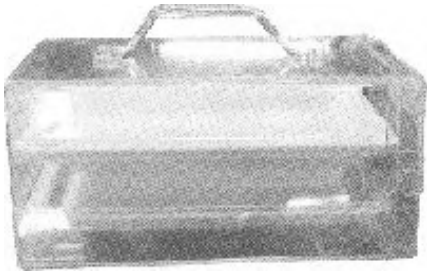

Formlin Chamber
Size-14",19",21",24",30"
2037



Fibre Optic Cold Light Source
Twin Bulb 24Vx250W
2040



Fibre Optic Cable
Dia-3.5mm,4.5mm
Length-7.5 Feet
2043



Fibre Optic headlight with
lightweight headband
2046



Clar headlight
2049

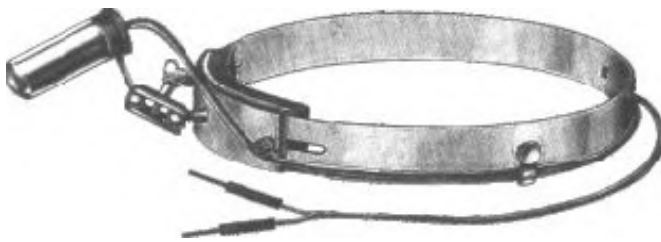

Jansen headlight
2052



Transformer for headlight
2055



Head Light LED
Riester German
2055



GENERAL INSTRUMENTS & EQUIPMENTS

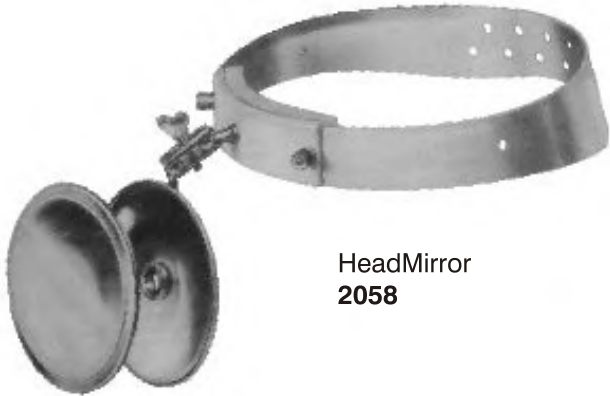

HeadMirror
2058



BullsEyelamp
2061



MicroAnglehandpiece
2070



MicroMotorwithfootswitch
Imported&T ransformer
2064



MicroStraighthandpiece
2067



HandPiecSpray
2073



BinocularLoupe
Magnification2.5x,4.0x
2079

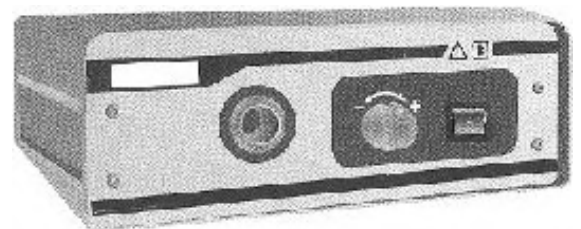

UltraCompactMiniX enonLightSource
2082



SurgicalTraywithLid
Size-6"x8", 9"x6", 10"x8",
11"x7", 12"x8", 12"x10",
14"x10", 15"x12"
2085



DressingDrums
Seamlessstainlesssteel
Size-6"x 6", 9"x9",
9"x11", 12"x12"
2088



MeasuringBowl
2091

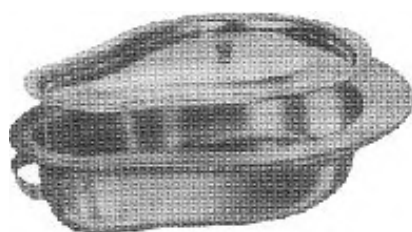

BedPanStainlessSteel
Male&F emale
2094



BowlStainlessSteel
Size-3", 4", 5", 6", 8"
2097



KidneyTrey
Size 8"x10
2100



SuctionMachineElectric
2103

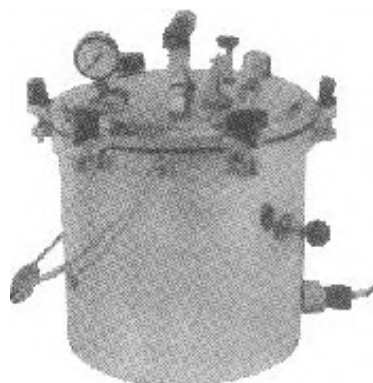

PortableSingleDoubleDrum
AutoclaveS.S.Heavy -duty
2106 SingleDrum
2106 DoubleDrum



FlexibleExamineLight
FiberOptic
2109



Suction
 Spray
 MirrorRewarmer
 HeadLight
 DoctorsChair
 InstrumentsTray
 X-rayLobby
 ColdLightsource
 Otoscope
 Cauty



2118
 Suction
 Spray
 MirrorRewarmer
 HeadLight
 DoctorsChair
 InstrumentsTray
 X-rayLobby
 ColdLightsource
 Otoscope
 Cauty

PatientChair
 "Seethro"cabinet
 Doctor'sChair
 Microscope
 Endoscope
 Camera

2124



Head:Zoombinocularopticalsystem
 Eyepieces:SWF15Xwith ±5dioters
 Magnification:Straightbinoculartube
 IPD:55mm-75mm
 Fieldofview:52mm-10mm
 Workingdistance:F=200mm
 Focusing:54mmManual

Coaxial54mmfieldofillumination
 Maximumintensity90,000lux(variable)
 15v-150wHalogenwinbulb
 OpticalFibrelightguidesystem
 Coolingbyinbuiltfansystem
 Counterbalancehydraulicswivelarm
 Horizontallengthofarm:860mm
 Verticalheightadjustmentrange:300to560mm
 Rotationofarm:320withlock

Mobileheavyfloorstandonfivecasterlockablewheel
 Easyhandlingandabsolutestability

AC220-240volts,50Hz



2127

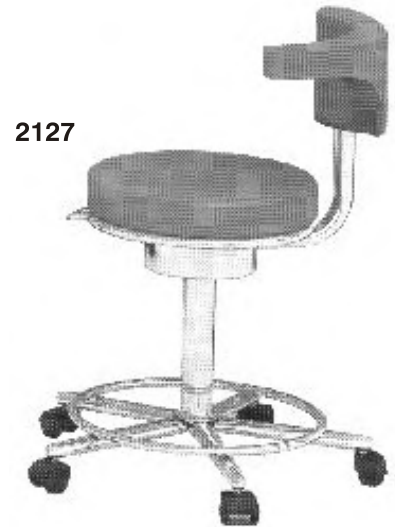

2127



2130



2133



without heating process
Specification from Sturdy 2ltrs UC -80
2136

2142

Overall approx. Size:
800mm L x 600mm W x 1408mm H.
One drawer & 4 shelves.
Oxygen cylinder cage & I.V. Rod.
Mounted on 125mm dia casters.
Switch & Socket panel for medical
equipment.
Epoxy powder coated.
Weight 35Kg.





2139



ELECTROSURGICAL UNIT

Owing to our advance and latest technology, we are offering electrosurgical equipment which is versatile; convenient compact device. It is designed with all latest features which is suitable for visiting consultants, clinics, nursing home, hospitals and for all general surgical procedures. This particular unit provides optimum power for general surgical procedures to perform the users satisfaction.

It is a digital display push switch control providing consistent performance for general surgical procedures and delivers optimum and reliable power. Our electrosurgical equipment is extremely convenient for visiting consultants due to compact and lightweight nature of the device.

- Monopolar Handle with cable
- Monopolar twin button Handle with cable
- Reusable Metal plate with cable
- Silicon Rubber plate with cable
- Bipolar Forceps with cable
- Monopolar Electrode 5 Nos
- Double Pedal Foot Switch for Monopolar
- Single Pedal Foot Switch for Bipolar

Input Voltage 180-270VAc
 Current Fuse 5Amps
 Power Consumption 550Max.

Digital display of power with LED Indicator of different modes and push switch control in all modes.

Unit construction As per IEC -60601-1-2&60601-2
 Protection Class I
 Unit Type CF
 Output All floating Output

Measuring Frequency 125KHz
 PPFM pad 5-125
 Non-PPFM pad cond. Not < .10
 AUDIO LEVEL Fix level of audiotone.
 WEIGHT 4.5Kg
 DIMENSION 295x120x285(LxHxW)mm



214523216

Portable Type Sterilizer
Micro-Processor Control System

Feature:

- Widerange use: suitable for wrapped/un-wrapped in ophthalmic clinics and hospitals.
- Easy maintenance: sterilizer and the heater is made by stainless steel, so it is easy to keep clean & maintain.
- Sterilization pressure are adjustable from 0.9 to 2.1 kg/cm² (approx. 115 °C-134°C) sterilization time 4 minutes/15 minutes/30 minutes for selection.
- Automatic control from heating up sterilization to time off
- The entire sterilization process is continuously monitored by a micro-processor indications system, which indicate the program working steps.
- Low water level protection system: the electric power will be cut-off, when the water level too low.

Model No.	SA-232X
Chamber Size	Stainless Steel #304 230mm Øx390mm(D)
Chamber Capacity	Approx. 16Ltrs.
Overall	501(W)x406(H)x537(D)mm
Power Consumption	220V-240V/1.5KW(max.)/6.5A
Using Pressure	#Unwrapped/Wrapped/Liquid
& Temperature	115°C- 134°C/0.9-2.1kg./CM ²
Design Temperature	140°C
Safety Devices	Over Heat (low water) cutoff switch safety valve & release valve emergency exhaust valve, door safety holder pressure control switch
Safety Approval	CE-EMCLVD, approved, CE -MDD approved Chamber designed by ASME/ U.S.A. Standard
Standard Accessories	Stainless steel #304, sterilization box/1 pc. Stainless steel #304 tray/1 pc.

Note:- Also available Model: **230260** with Microprocessor Temperature Controlled System.

Pre-Vacuum & Dry Vacuum



Caw Throne Hooks Set (Set of 8 Instruments) S. Steel & Titanium

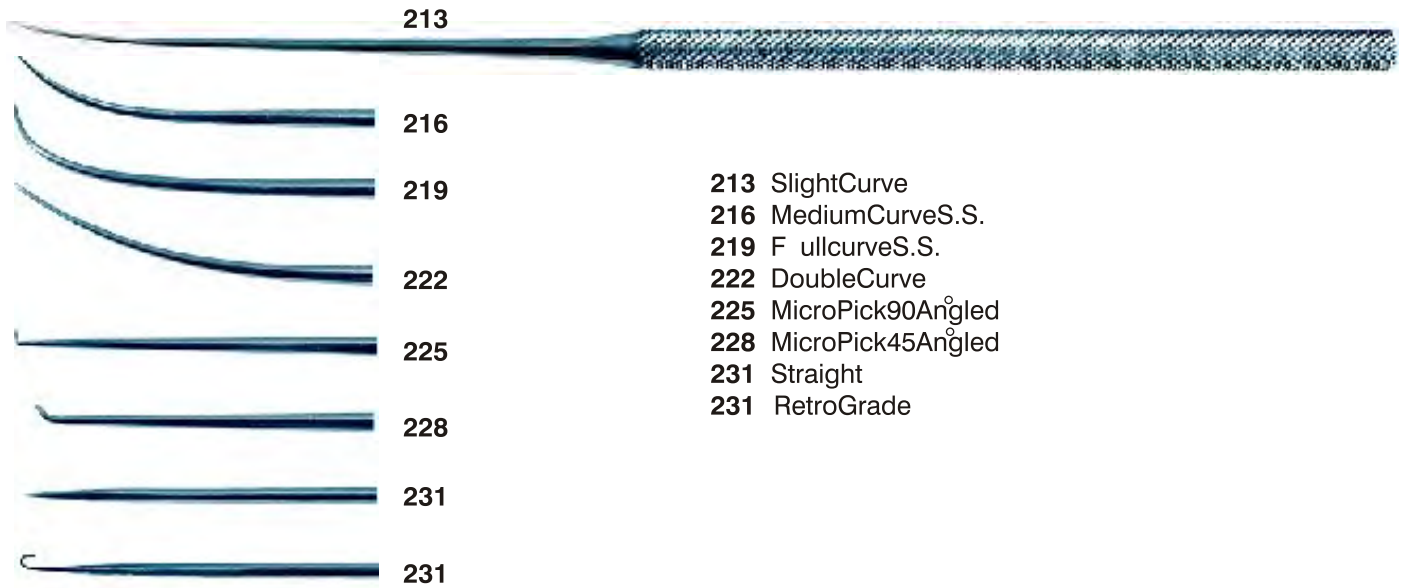

- 213 SlightCurve
- 216 MediumCurveS.S.
- 219 FullcurveS.S.
- 222 DoubleCurve
- 225 MicroPick90Angled
- 228 MicroPick45Angled
- 231 Straight
- 231 RetroGrade

Stapedotomy Set (Set of 9 Instruments) S. Steel & Titanium

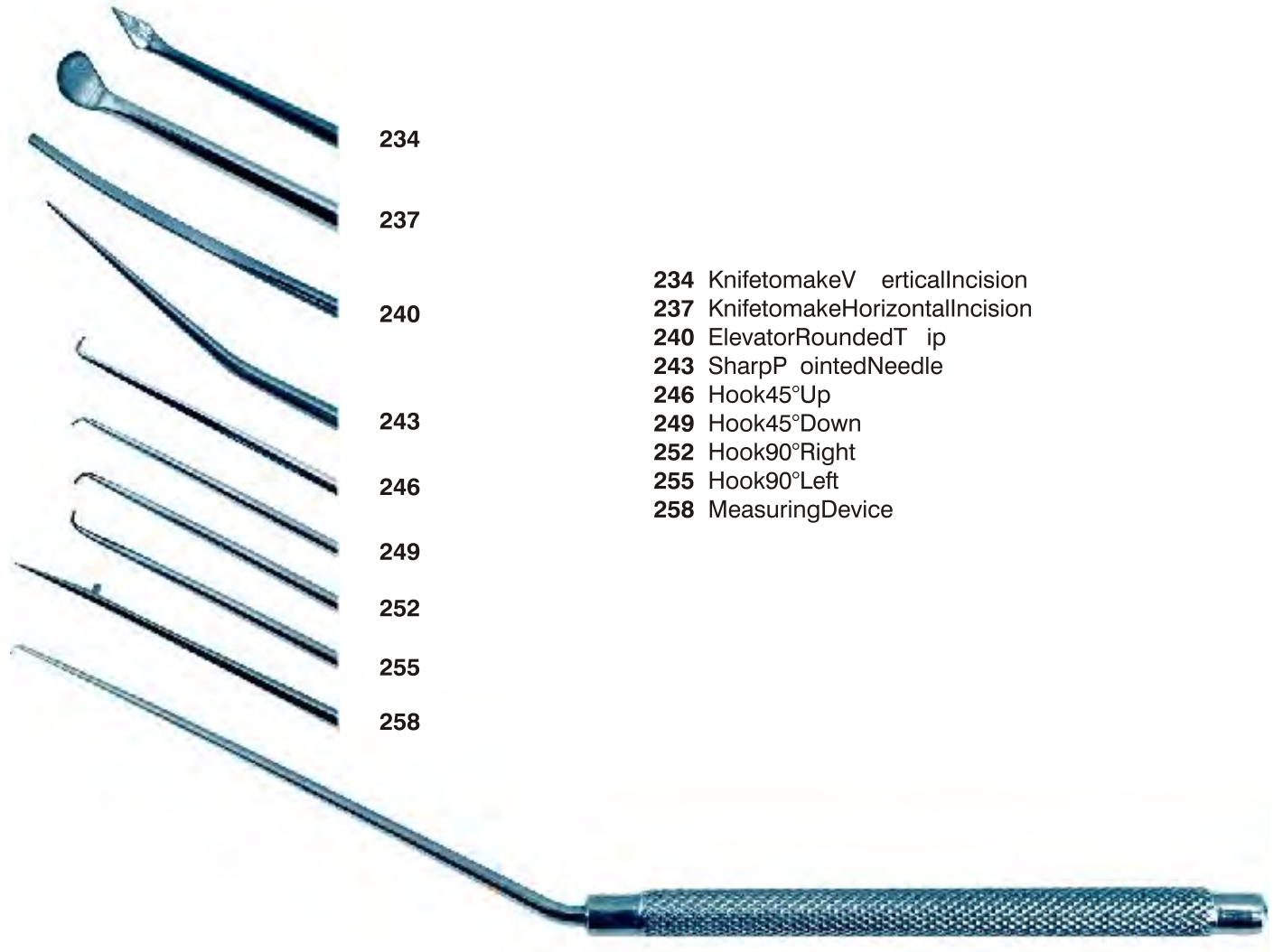

- 234 KnifetomakeVerticalIncision
- 237 KnifetomakeHorizontalIncision
- 240 ElevatorRoundedTip
- 243 SharpPointedNeedle
- 246 Hook45°Up
- 249 Hook45°Down
- 252 Hook90°Right
- 255 Hook90°Left
- 258 MeasuringDevice

Shea Ear Operating Set (Set of 11 Instruments) S. Steel & Titanium

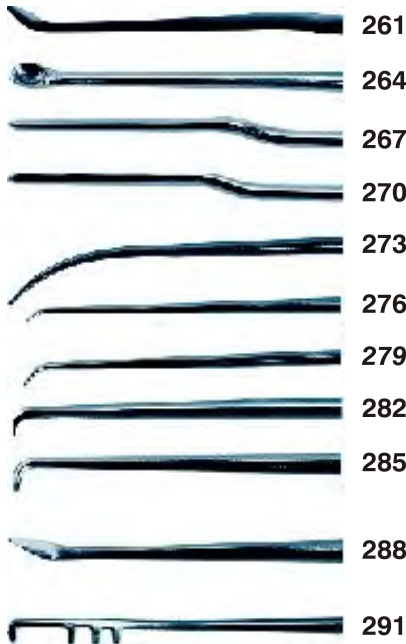

- 261 IncisingKnifeangularsheft
- 264 CuretteStraight
- 267 ElevatorStraight-SheftLeft
- 270 ElevatorStraight-SheftRight
- 273 CurvedNeedle
- 276 FenestraHookStraightShaft25°angle
- 279 FenestraHookStraightShaft45°angle
- 282 FenestraHookStraightShaft90°angle
- 285 FenestraHookStraightShaft90°angleshort
- 288 AnteriorCrurotomyKnifeStraightShaft
- 291 SHEAPistonDepthGauge3.5mm,4mm&4.5mm

Zoellner Set (Set of 7 Instruments) S. Steel & Titanium

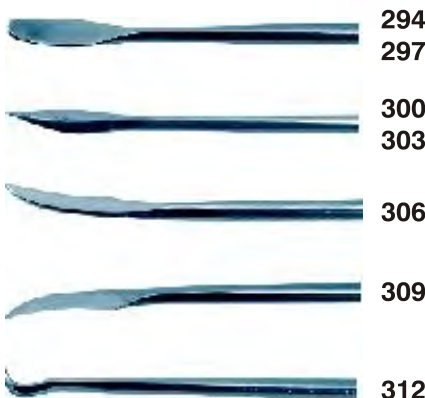
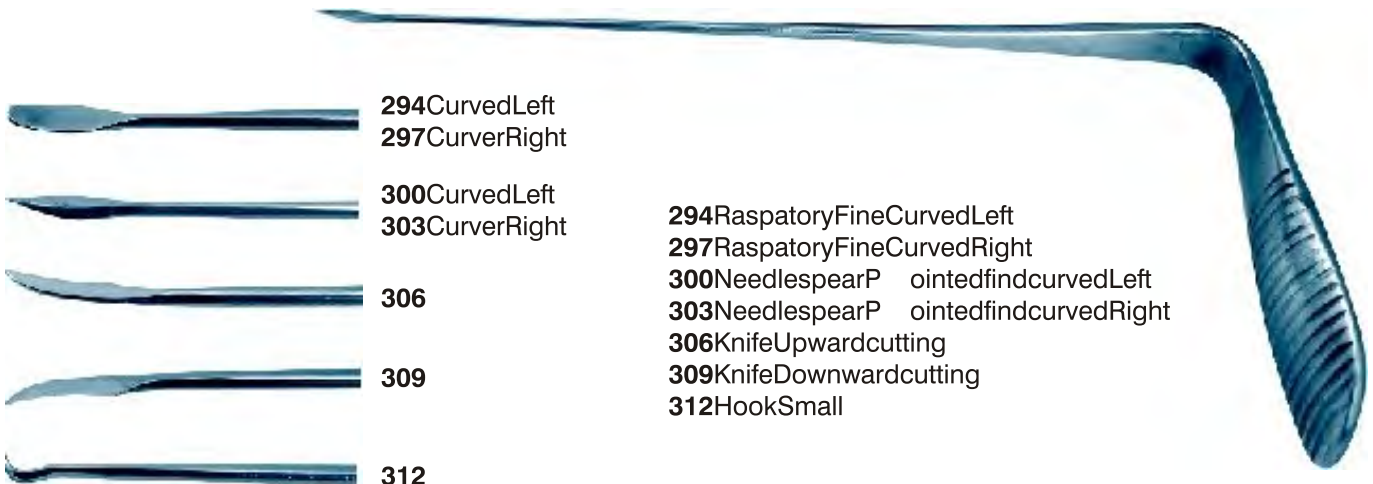

- 294RaspatoryFineCurvedLeft
- 297RaspatoryFineCurvedRight
- 300NeedlespearP ointedfindcurvedLeft
- 303NeedlespearP ointedfindcurvedRight
- 306KnifeUpwardcutting
- 309KnifeDownwardcutting
- 312HookSmall



Austin Middle Ear Set (Set of 12 Instruments)



①



②



③



④



⑤



⑥



⑦



⑧



⑨



⑩



⑪



⑫

1	318	PLESTER First Incision Knife	7	351A	Wallstein needle curved sharp & blunt
2	321	SICKLE Knife	8	354	ROSE Curette Curved Straight Shaft
3	327	MYRINGOTOMY Knife	9	363	LARKIN Perforator
4	330	Circular Cutting Knife 60°	10	366	House Measuring Rod 3.5/4.0/4.5mm
5	348	ROSE Elevator for Lifting Drum	11	369	Hook Ball end bent 45°
6	351	Wallstein straight needle sharp & blunt	12	372A	House Curette double ended slightly

Myringotomy Set (Set of 15 Instruments)

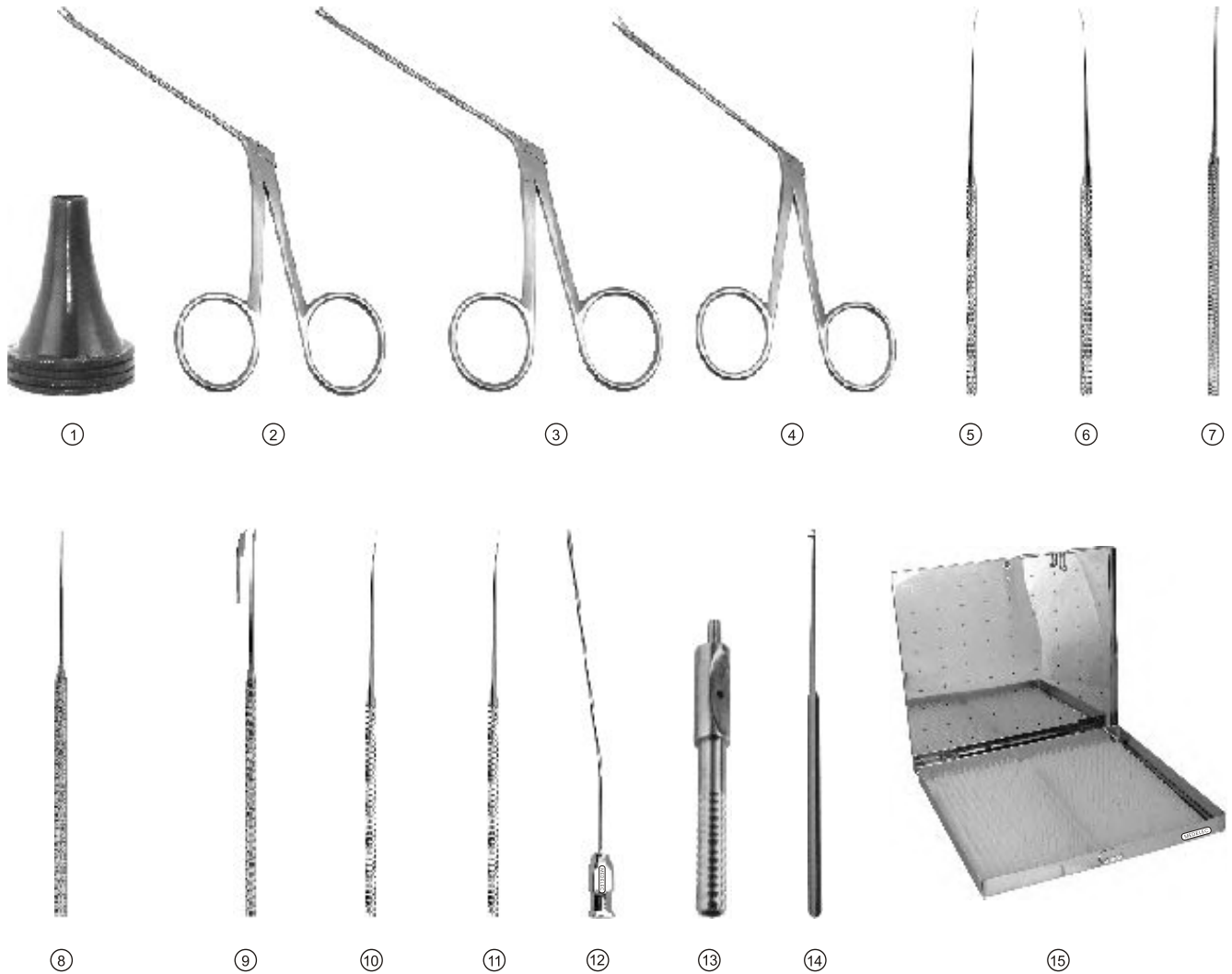

- | | | | | | |
|---|-----|--|----|-----|--|
| 1 | 6 | Hartman Ear Speculum Black Finish (Set of 4) | 9 | 321 | Sickle Knife |
| 2 | 156 | Micro Crocodile Forceps St. Serrated | 10 | 228 | Micro Pick 45° 0.8mm |
| 3 | 168 | Micro Crocodile Cup Forceps Straight | 11 | 225 | Micro Pick 90° Angled |
| 4 | 180 | Micro Crocodile Scissors Straight | 12 | 150 | Suction Cannula (Any size 5 nos.) |
| 5 | 231 | Wullstein Needle Straight | 13 | 153 | Suction Adopter |
| 6 | 213 | Wullstein Needle Slightly Curved | 14 | 42 | Buck Ear Curette |
| 7 | 318 | Plaster Flap Knife for Incision | 15 | 390 | Micro Instruments Case with double silicon mat large |
| 8 | 330 | Rosen Circular Knife 45° Angled | | | |



Tympanoplasty Set (Set of 22 Instruments)

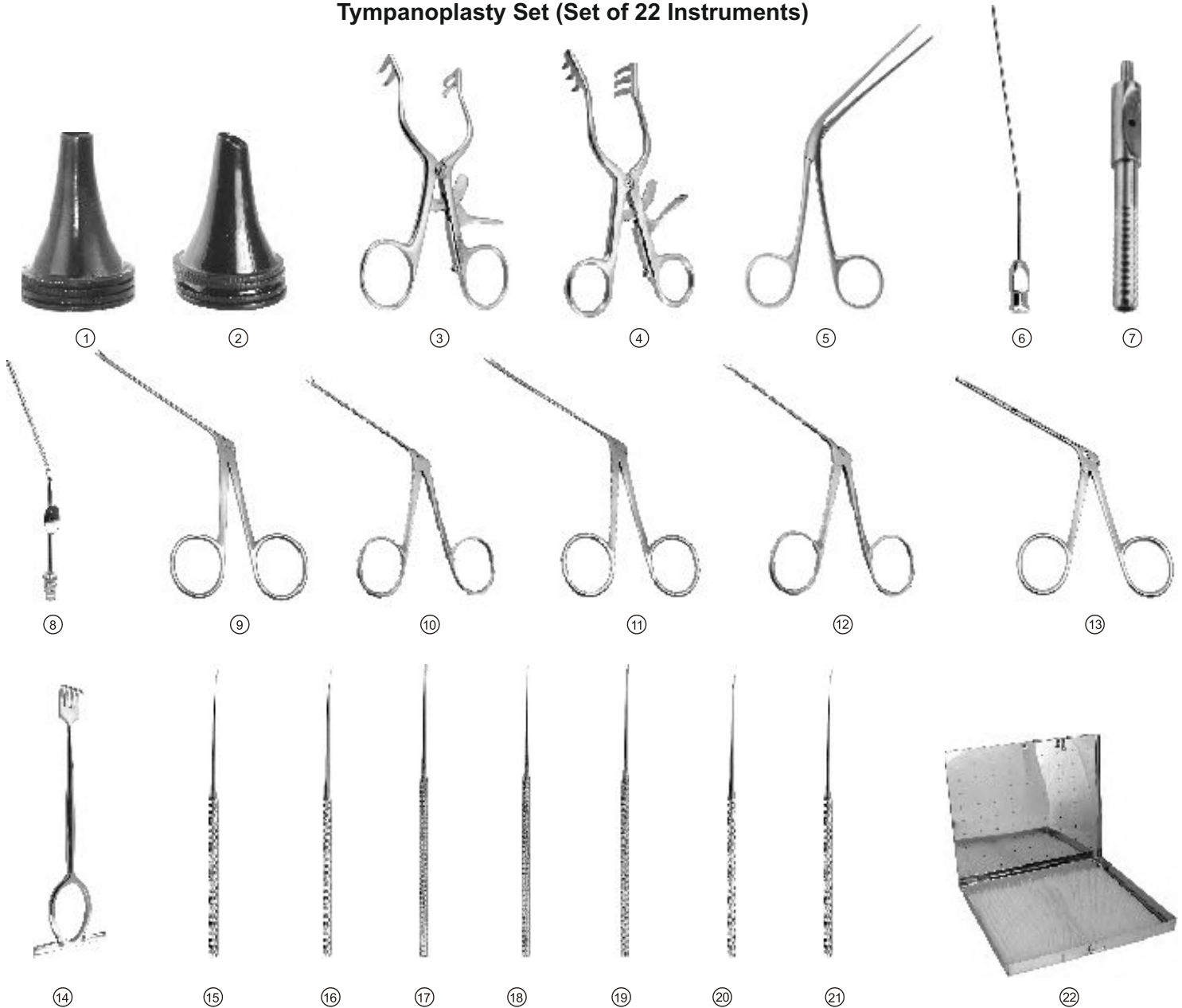

- | | | | | | |
|----|-----|--|----|-----|--|
| 1 | 6 | Hartman Ear Speculum Black Finish (Set of 4) | 13 | 207 | House Dieter Malleus Nipper Upward |
| 2 | 18 | Aural Speculum Shea | 14 | 429 | Hand Retractor |
| 3 | 93 | Plaster Retractor 2x2 prongs | 15 | 231 | Wullstein Needle Straight |
| 4 | 96 | Wullstein Retractor 3x3 prongs | 16 | 213 | Wullstein Needle Slightly Curved |
| 5 | 78 | Tilley Dressing Forceps | 17 | 318 | Plaster Flap Knife Forceps Incision |
| 6 | 150 | Suction Cannula (Any size 5 nos.) | 18 | 330 | Rosen Circular Knife 45° Angled |
| 7 | 153 | Suction Adaptor | 19 | 321 | Sickle Knife |
| 8 | 144 | Mastoid Suction Cannula | 20 | 228 | Micro Pick 45° 0.8mm |
| 9 | 156 | Micro Crocodile Forceps Serrated Straight | 21 | 225 | Micro Pick 90° Angled |
| 10 | 168 | Micro Crocodile Cup Forceps Straight | 22 | 390 | Micro Instruments Case with double silicon mat large |
| 11 | 180 | Micro Crocodile Scissors Straight | | | |
| 12 | 192 | Mc. Gee Wire Crimper | | | |

Mastoid Surgery Set (Set of 28 Instruments)

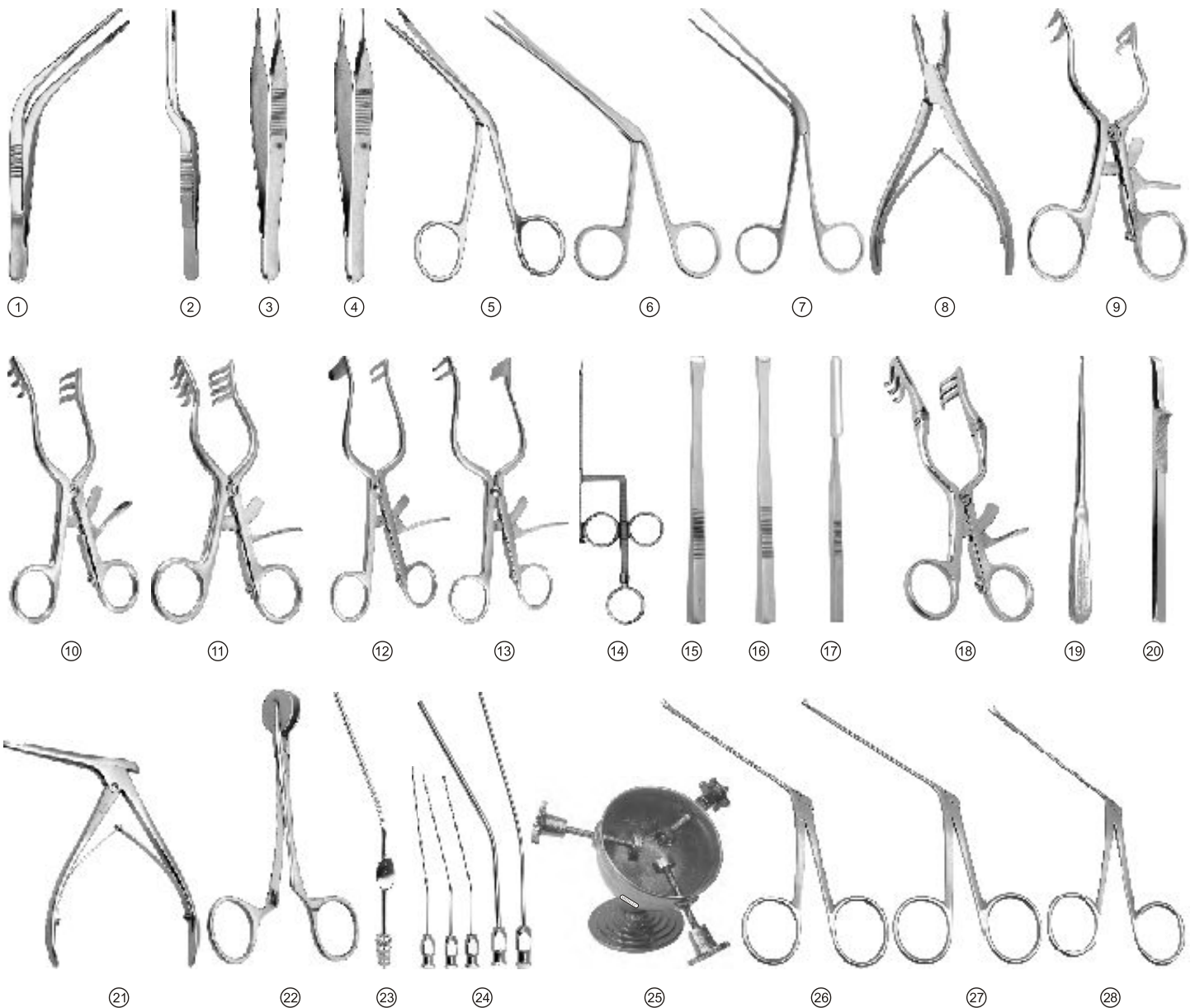

- | | | | | | |
|----|-----|--|----|------|--------------------------------------|
| 1 | 60 | WildAuralF orcepsLarge | 15 | 117 | JANSENChisel |
| 2 | 63 | FAGGEAuralBayonetF orceps | 16 | 120 | JANSENOSTeotome |
| 3 | 66 | ADSONPlainF orceps | 17 | 123 | JENKINSGouge |
| 4 | 69 | ADSONForcepswith1x2teeth | 18 | 126 | ConeSelfRetainingAdjustableRetractor |
| 5 | 72 | HARTMANAuralF orceps | 19 | 129 | LEMPERETMastoidCurette |
| 6 | 75 | OSSICLEHoldingF orceps | 20 | 132 | FARABEUFElevatorCurved |
| 7 | 78 | TILLEYAuralF orceps | 21 | 135 | KERRISONBonePunch |
| 8 | 87 | LEMPERTRonguerCurved | 22 | 141 | HOUSESGraftPressF orceps |
| 9 | 93 | PLESTERSelfRetainingRetractor2x2Prongs | 23 | 144 | MASTOIDSuctionT ube |
| 10 | 96 | WULLSTEINSelfRetainingRetractor3x3Prongs | 24 | 150 | SuctionTube-Set&Holder |
| 11 | 99 | WULLSTEINSelfRetainingRetractor4x4Prongs | 25 | 153A | TemporalBoneHolder |
| 12 | 108 | PLESTERJANSENRetractorSolidBladeLeft | 26 | 156 | MicroAuralCrocodileF orceps |
| 13 | 111 | PLESTERJANSENRetractorSolidBladeRight | 27 | 168 | MicroCrocodileCupF orceps |
| 14 | 114 | GLEGGAuralSnare | 28 | 180 | MicroCrocodileScissors |



Septorhinoplasty Set (Set of 25 Instruments)

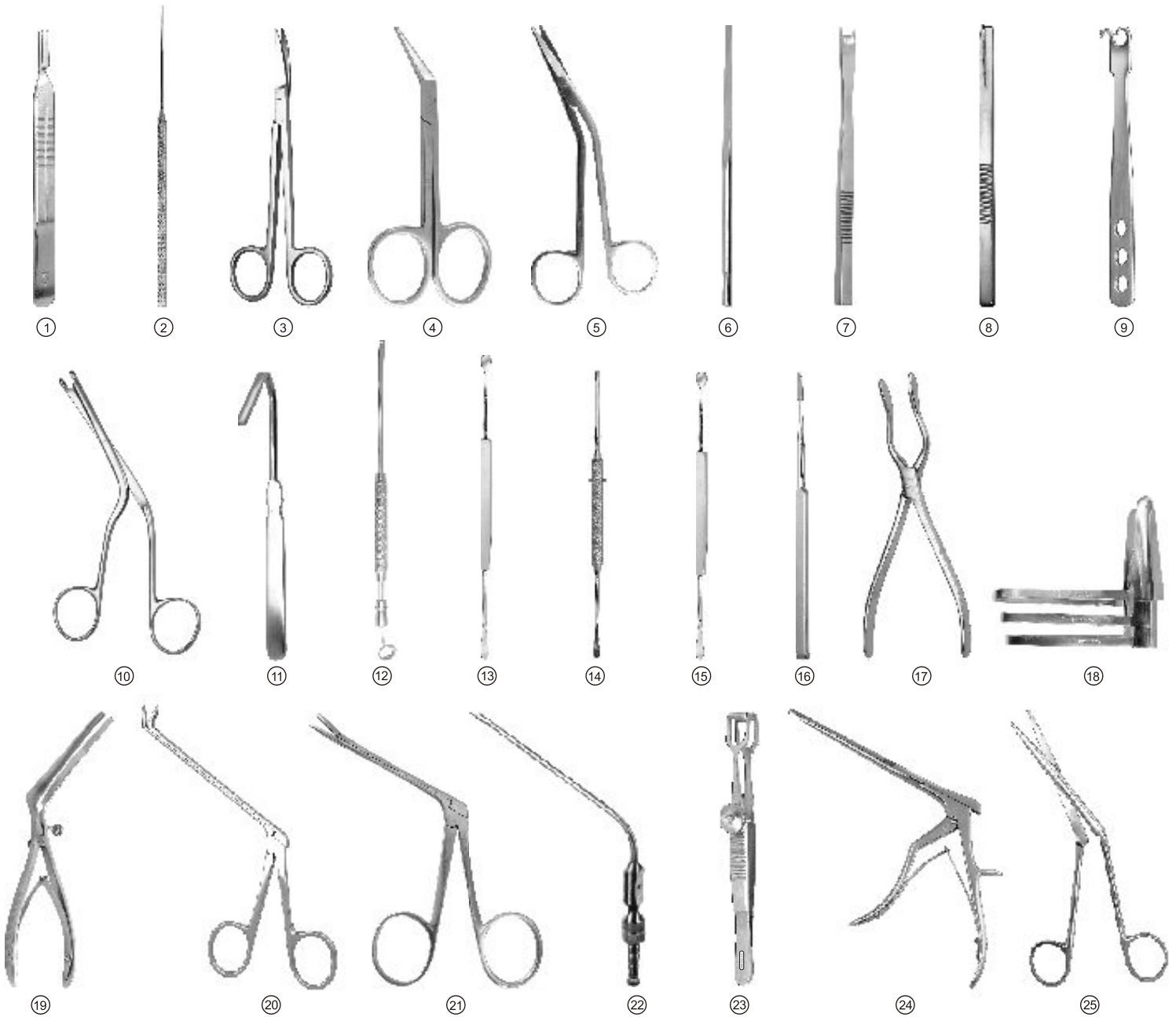

- | | | | | | |
|----|-----|------------------------------------|----|-----|--------------------------------------|
| 1 | 894 | ScalpalHandleLong | 14 | 438 | FreerElevator |
| 2 | 330 | CottleNasalKnifeRoundedEdge | 15 | 606 | JOSEPHNasalRaspFine |
| 3 | 516 | JosephPlasticScissors | 16 | 603 | CottleMasingNasalRaspCoarse |
| 4 | 501 | WalterScissorsAngled10cm | 17 | 549 | WALSHAMSeptumst.F orcep |
| 5 | 483 | FomanAngularScissorsSerratedBlades | 18 | 408 | ThudicumNasalSpeculum |
| 6 | 594 | CottleChiselStraight | 19 | 402 | KillianSpeculumSetof4 |
| 7 | 573 | CottleOsteotomeStraight | 20 | 720 | BlacksleyNasalF orcepsupward45degree |
| 8 | 576 | MasingChiselwithGuard | 21 | 531 | WatsonWilliamPolypusForcepsSerrated |
| 9 | 423 | CottleAlarRetractor | 22 | 648 | FrazierSuctionCannula |
| 10 | 492 | LucsNasalF orceps | 23 | 621 | CottleColumellaF orceps |
| 11 | 570 | AufrichtRetractor | 24 | 567 | BoneCuttingF orceps |
| 12 | 456 | SuctionElevatorBay ,22cm | 25 | 468 | HeymanNasalT urbinectomyScissors |
| 13 | 441 | MasingDoubleElevator ,Graduated | | | |

Paranasal Sinus Surgery Set (Set of 18 Instruments)

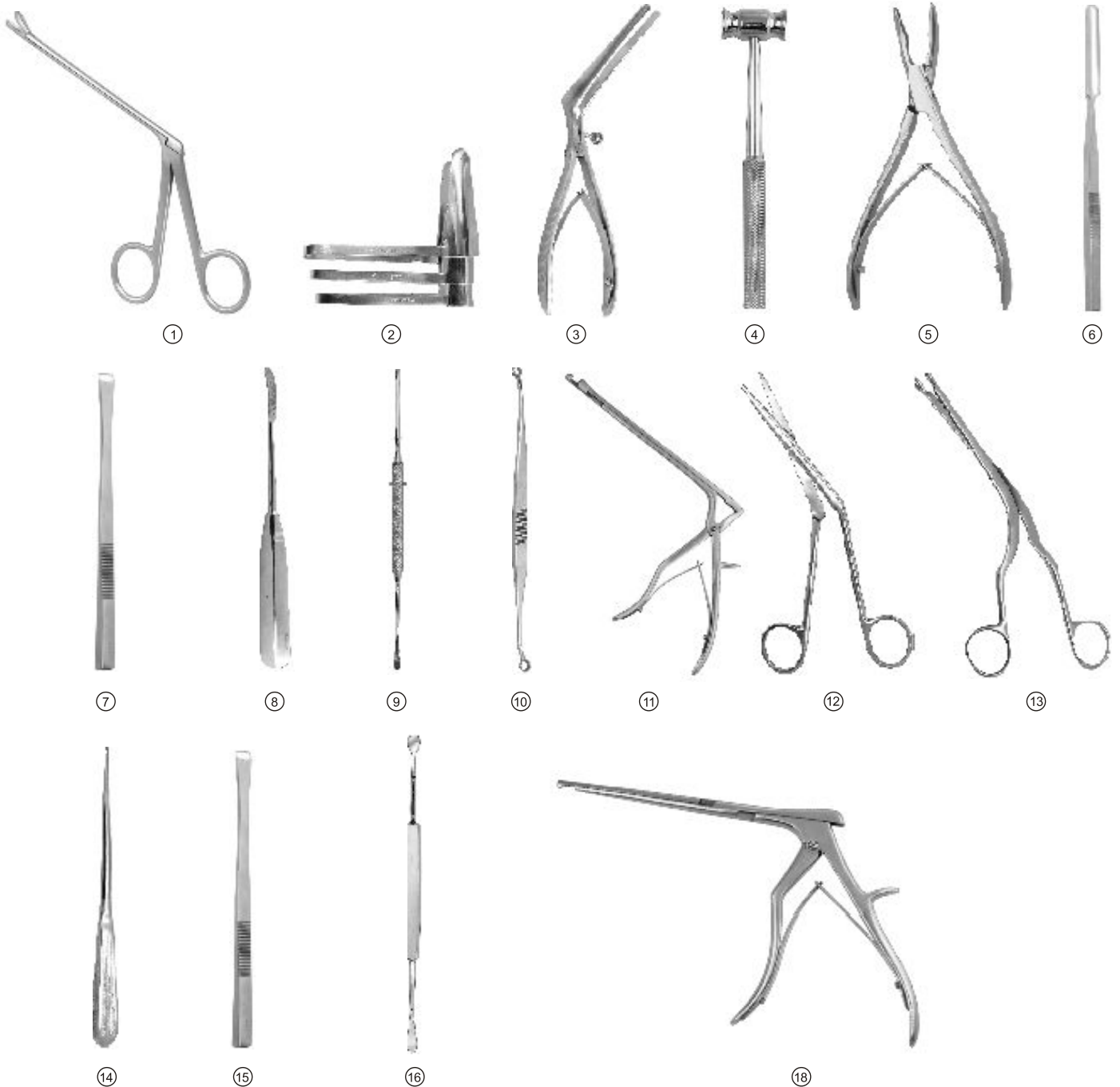

- | | | | | | |
|---|-----|-------------------------------|----|-----|-----------------------------------|
| 1 | 720 | BlaksleyNasalF orcepsStraight | 10 | 663 | FaulknerAntrumCurette |
| 2 | 408 | ThudicumNasalSpeculum | 11 | 717 | CiteliAntrumPunch |
| 3 | 402 | KillianSpeculumSetof4 | 12 | 468 | HeymannNasalT urbinectomyScissors |
| 4 | 591 | Mallet | 13 | 489 | HartmanNasalCuttingF orceps |
| 5 | 87 | BayorRongeur | 14 | 129 | HaleAntrumCurette |
| 6 | 123 | TrautmanMastoidGauge | 15 | 117 | PassowChisel |
| 7 | 117 | JansenChisel | 16 | 441 | MasingElevatorDoubleEnded |
| 8 | 600 | WullsteinRaspatoryCurved | 17 | NI | MetazenbaumScissorsCurved |
| 9 | 438 | FreerElevatorDoubleEnded | 18 | 567 | AntrumPunchThroughCutting |



DCR Surgery Set (Set of 20 Instruments)

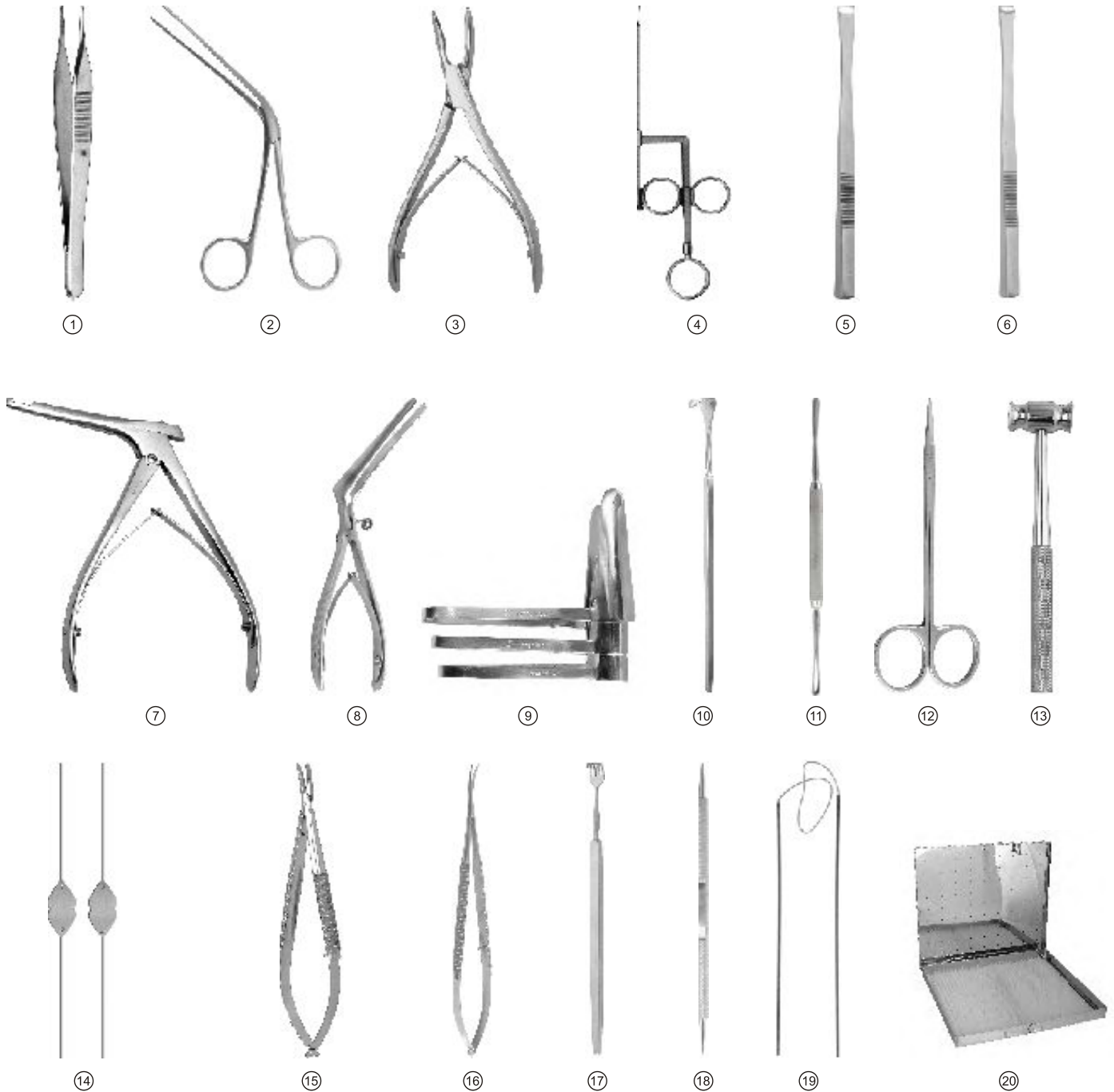

- | | | | | | |
|----|------|------------------------------------|----|------|--------------------------------------|
| 1 | 69 | ADSON Tooth Forceps | 11 | 447 | Periosteal Elevator |
| 2 | 78 | TILLEY Packing Forceps | 12 | 507 | Fine Dressing Scissors |
| 3 | 87 | LEMPERTRongeur Curved | 13 | 591 | Mallet |
| 4 | 117 | JANSEN Chisel | 14 | 627A | BOWMAN Lacrimal Probe Set (Set of 4) |
| 5 | 120 | Osteotome | 15 | 627D | Spring Needle Holder |
| 6 | 123 | Jenkin Gauge | 16 | 627F | Spring Scissors Curved |
| 7 | 135 | KERRISON Bone Punch | 17 | 627G | Catpaw Retractor |
| 8 | 402 | Killian Nasal Speculum | 18 | 627H | Lacrimal Dialator |
| 9 | 408 | Thudicum Nasal Speculum (Set of 3) | 19 | 627I | Lacrimal Intubation (Stent) |
| 10 | 420A | COTTLE Upper Lateral Retractor | 20 | 390A | Sterilization Box with double mats |

Fess Surgery Set (Set of 21 Instruments)

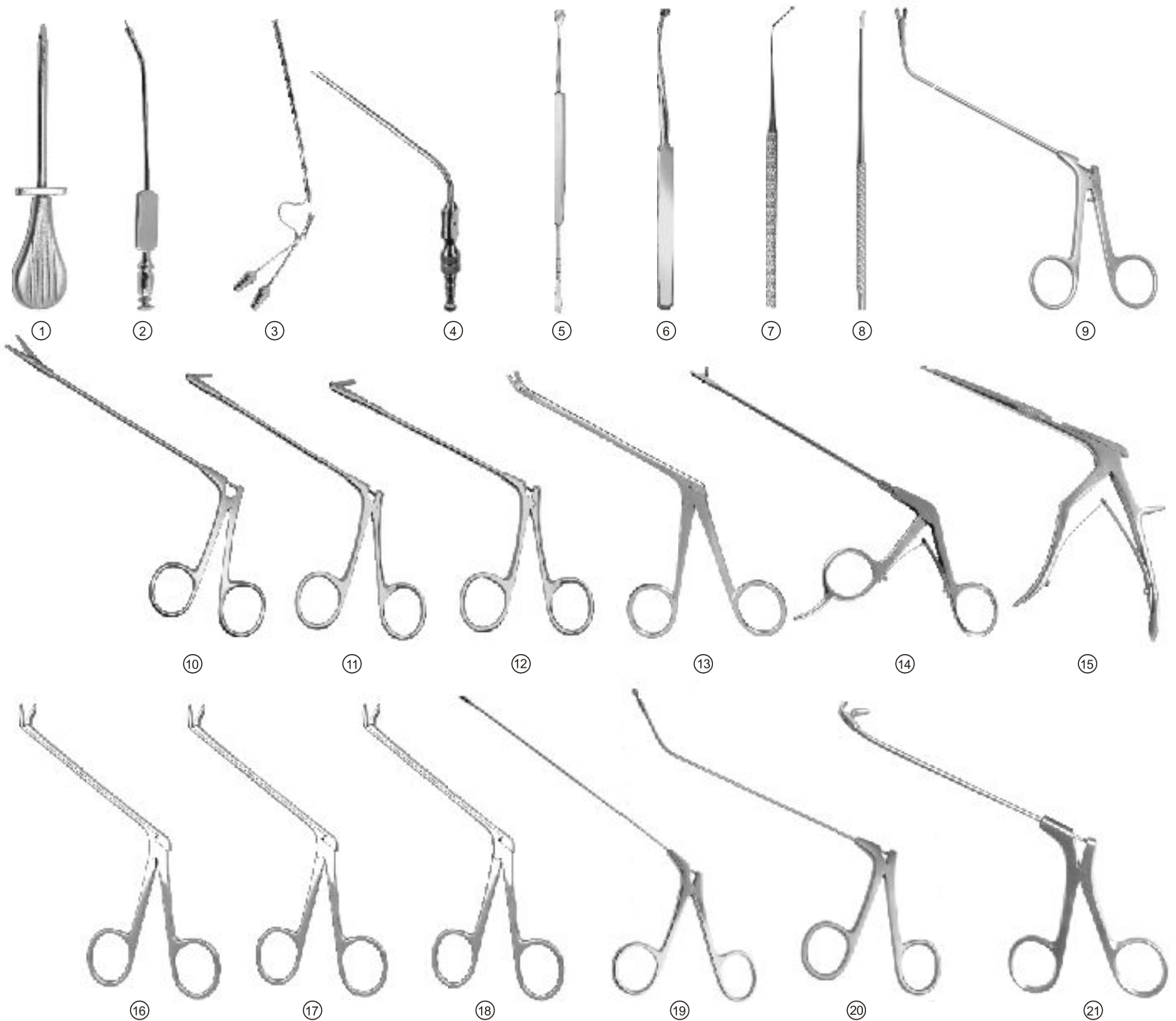

1	639	TrocarandcannulaLength8.5cm	12	687	AntrumPunchBackwardCuttingDownward
2	642	AntrumCannulaCurved	13	738	SuperPunchThroughCuttingUpward
3	645	SuctionIrrigationT ubewithChannel Forinflow&outflow	14	699	SuperPunchThroughCuttingStraight
4	648	FrazierSuctionCannula	15	708	AntrumPunch360°Rotatable
5	651	MassingElevatorGraduated	16	720	BlaksleyNasalF orcepsStraight
6	654	AntrumCurette	17	723	BlaksleyNasalF orceps45°
7	666	AntrumBallProbe	18	726	BlaksleyNasalF orceps90°
8	669	SickleKnife	19	750A	MushroomForcepsStraight
9	675	GirafForcepsUpward	20	750B	MushroomForcepsUpward
10	678	NasalScissorsStraight	21	750C	AntrumGraspingF orceps
11	690	AntrumPunchBackwardCuttingUpward			



Tonsillectomy & Adenoidectomy Set (Set of 25 Instruments)

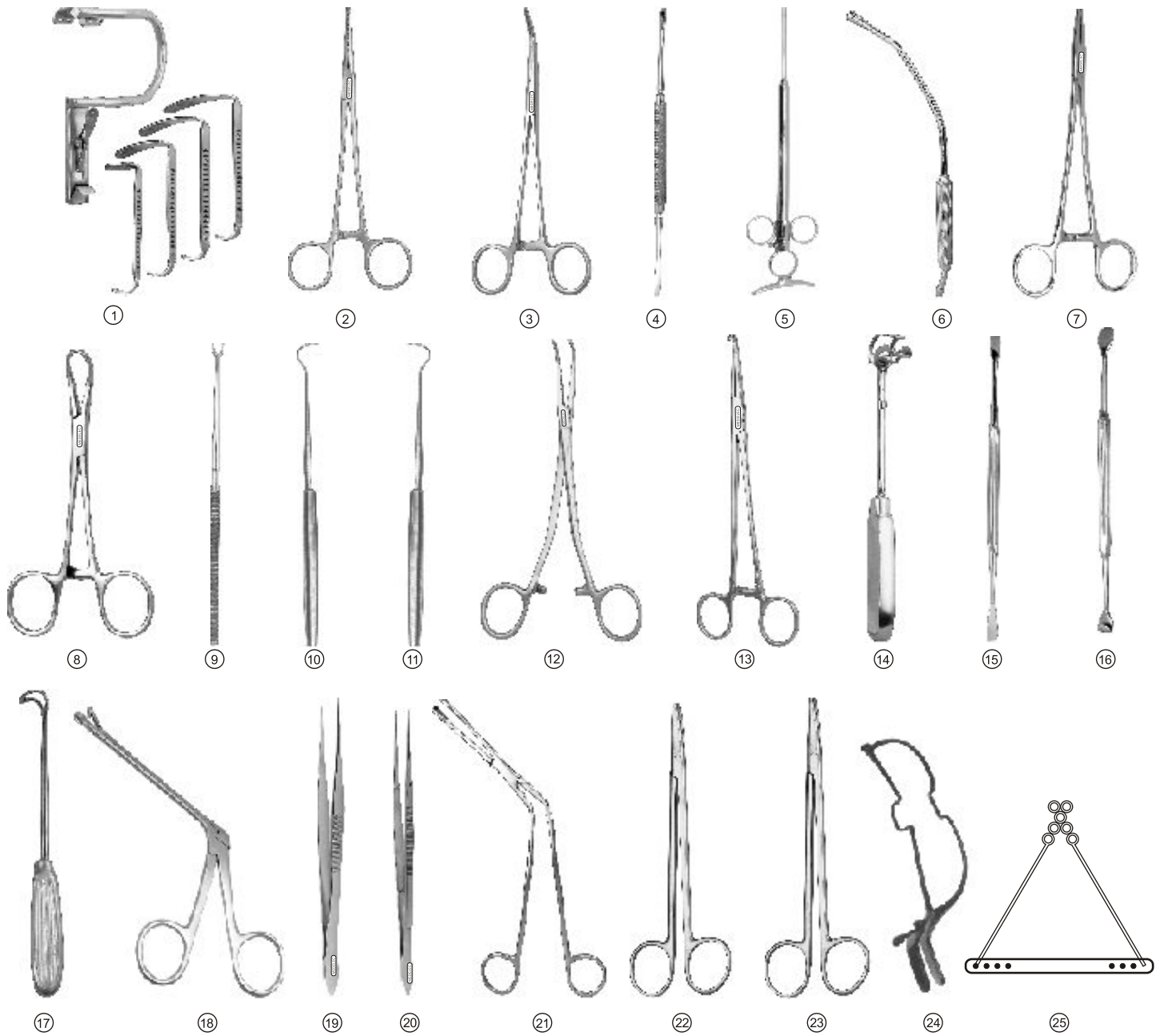

- | | | | | | |
|----|-----|--------------------------------------|----|-----|--|
| 1 | 834 | MouthGagDavisSetof5Blades | 14 | 831 | BackmanAdenoidCurettewithcaseSetof3 |
| 2 | 756 | TonsilArteryForcepsStraight | 15 | 804 | NegusTonsilRetractor |
| 3 | 759 | TonsilArteryForcepsCurved | 16 | 798 | NegusTonsilPillarDissector&Retractor |
| 4 | 450 | TonsilElevator | 17 | 828 | BackmanAdenoidCurettewithoutcageSetof2 |
| 5 | 786 | BrueningTonsilSnare | 18 | 852 | HartmanChochotome |
| 6 | 813 | YankurSuctionTube | 19 | 816 | WaughTonsilDissectingForcepsPlain |
| 7 | 780 | NeedleHolderTCCoated | 20 | 819 | WaughTonsilDissectingForcepsTooth |
| 8 | 864 | BackhouseTowelForceps | 21 | 774 | DenisBrowneTonsilHoldingForceps |
| 9 | 807 | NegusPusherKnotTier | 22 | 771 | TonsilScissorsStraight |
| 10 | 789 | IrwinMooreTonsilNeedleRight | 23 | 771 | TonsilScissorsCurved |
| 11 | 789 | IrwinMooreTonsilNeedleLeft | 24 | 825 | JENNINGSMouthGag |
| 12 | 762 | NegusTonsilArteryForcepsLongCurved | 25 | 843 | DRAFFINBipodStandwithPlates |
| 13 | 765 | NegusTonsilArteryForcepsLongStraight | | | |

Tracheostomy Set (Set of 12 Instruments)



①



②



③



④



⑤



⑥



⑦



⑧



⑨



⑩



⑪



⑫

1	879	LangenBeckRetractor	7	2004	AllisTissueForceps
2	876	TrachealDilatingForceps	8	864	BackhouseTowelForceps
3	882	TrachealRetractor2prongs	9	894	B.P.Handle
4	885	TrachealRetractor1prong	10	870	MosquitoArteryForcepsStraight
5	888	JacksonTracheostomyTubeSetof5	11	870	MosquitoArteryForcepsCurved
6	891	FullerTracheostomyTubeSetof5	12	882A	VolkmanRetractor



Micro Laryngeal Set (Set of 15 Instruments)



MicroLaryngeal Forceps serrated Jaw 25cm, 35cm
900 Straight



MicroLaryngeal Forceps Cup Jaw straight 25cm
912



MicroLaryngeal Scissors straight 25cm
924



Foreign Body Forceps 25cm
939



Biopsy Cup Forceps 25cm
945

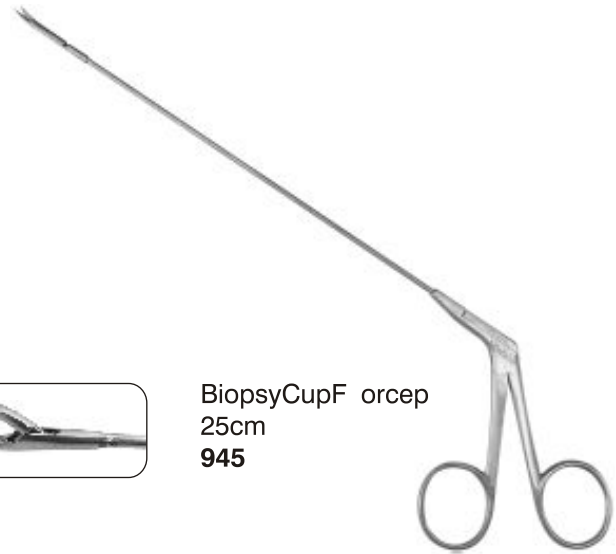

Laryngeal Suction Tube 25cm, 35cm
957



Bronchoscope Suction Tube 35cm, 45cm & 55cm
960



MicroLaryngeal Round Knife 45°
963



MicroLaryngeal Plaster Knife
966



MicroLaryngeal Probe 90°
972



MicroLaryngeal Sickle Knife
975



MicroLaryngeal Swab Holder
984

984 Holder for Micro Laryngeal Instruments



Anterior Commissure Laryngoscope with Fibre Optic Carrier Small/Med/Large
987



Laryngoscope Holder and Chest Support
999

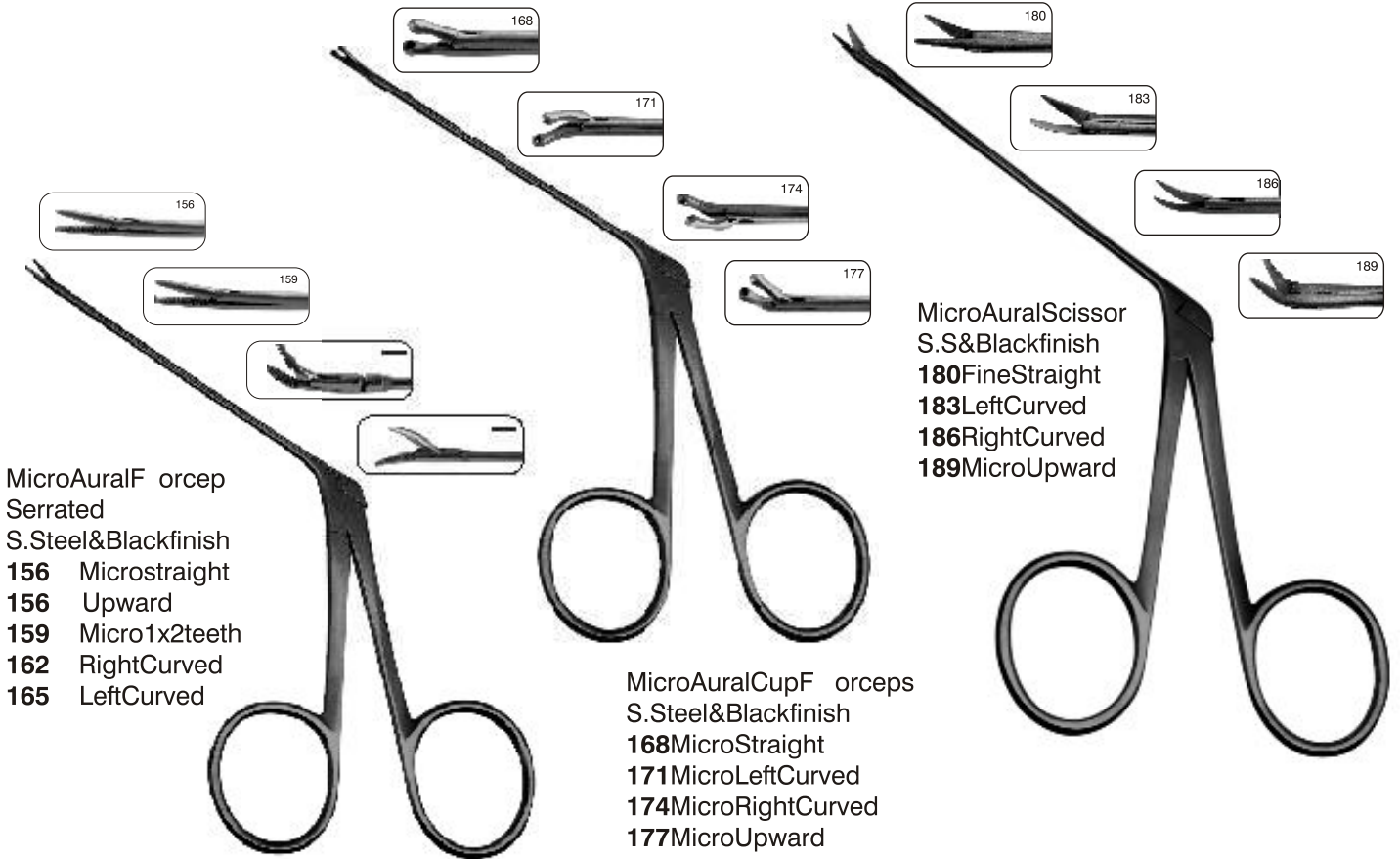

MicroAural Forceps
Serrated
S.Steel&Blackfinish
156 Microstraight
156 Upward
159 Micro1x2teeth
162 RightCurved
165 LeftCurved

MicroAural Cup Forceps
S.Steel&Blackfinish
168 MicroStraight
171 MicroLeftCurved
174 MicroRightCurved
177 MicroUpward

MicroAural Scissor
S.S&Blackfinish
180 FineStraight
183 LeftCurved
186 RightCurved
189 MicroUpward

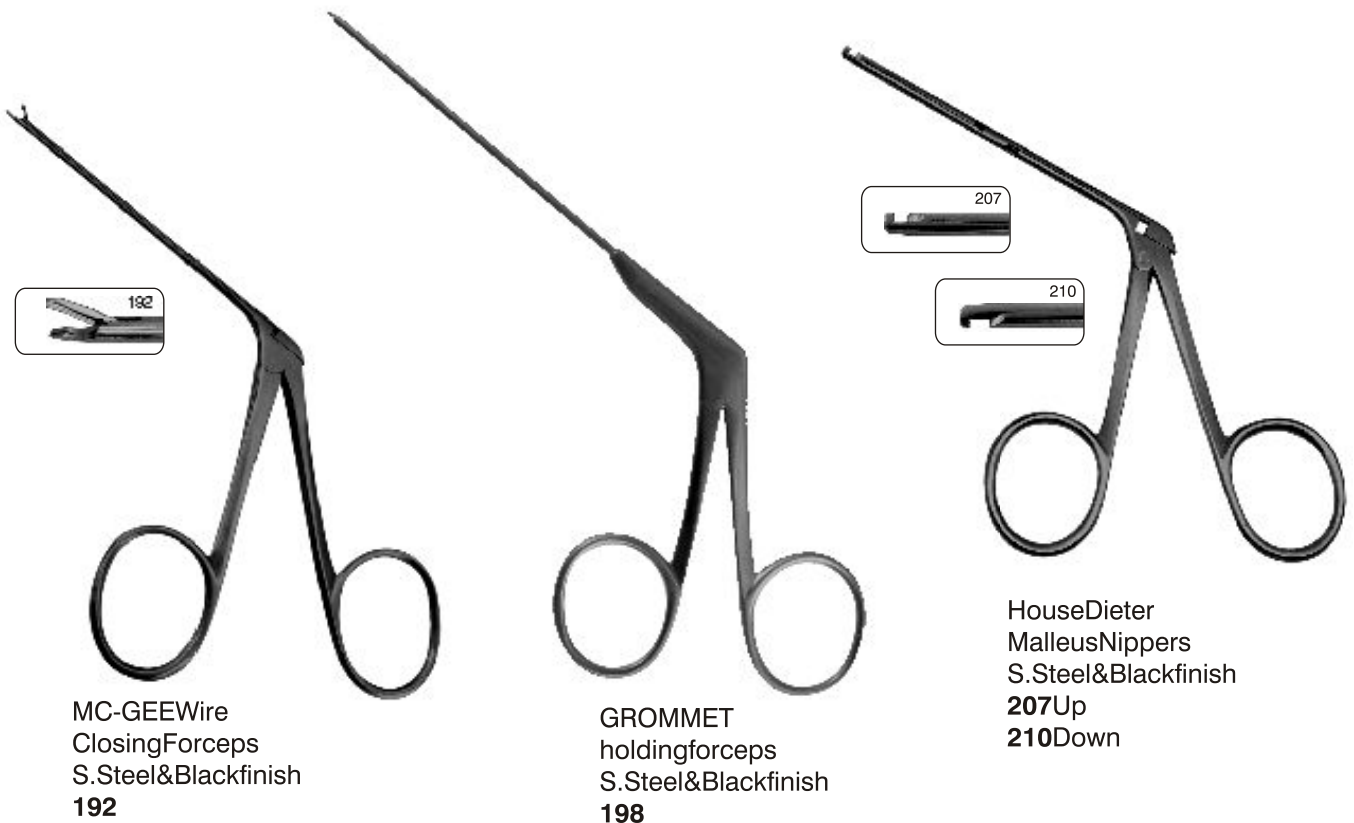

MC-GEE Wire
Closing Forceps
S.Steel&Blackfinish
192

GROMMET
holding forceps
S.Steel&Blackfinish
198

House Dieter
Malleus Nippers
S.Steel&Blackfinish
207 Up
210 Down



TriMed Technologies

Customise Surgical Solution & Instruments

4/E-1, Second Floor, Nuchana Tower,
Alaknanda Shopping Complex, Alaknanda, New Delhi - 110019 (INDIA)

Ph:- +91-11-41051188, Mobile:-+91-8459130431

Email: trimedtechnologies@gmail.com, info@trimed.co.in

Web: www.trimed.co.in